

# i<sup>3</sup> Versa 7X Intelligent Control Station



Technical Datasheet

## Key Features

- 7" TFT Colour Touch Screen Display
- 65,535 Colours, WVGA (800 x 480)
- MicroSD™ Data Storage up to 32GB
- Real Time Clock
- 2 CAN Ports, 3 RS-232 / RS-485
- 2 Integral Ethernet Ports
- USB Port for Programming
- USB Port for Flash Drives up to 2TB
- Addressable Function Keys
- IP65 (NEMA 4)
- 10 - 30 VDC Power Supply
- Free Configuration Software
- **Support for i3 OnCloud** NEW
- i3 RMI, MQTT as standard, J1939, Enhanced IEC



## Options & Ordering Codes

Standard Options	DI	DO	AI	AO
i3V7X/10D03-SEHF	12	6 Relay	4	-
i3V7X/13C14-SEHF	12	12	2*	2
i3V7X/20B05-SEHF	24	16	2	-
i3V7X/10B04-SEHF	12	12	2	-
i3V7X/10E24-SEHF	12	12	6*	4
i3V7X/00000-SEHF	-	-	-	-

\* Universal Analogue Inputs

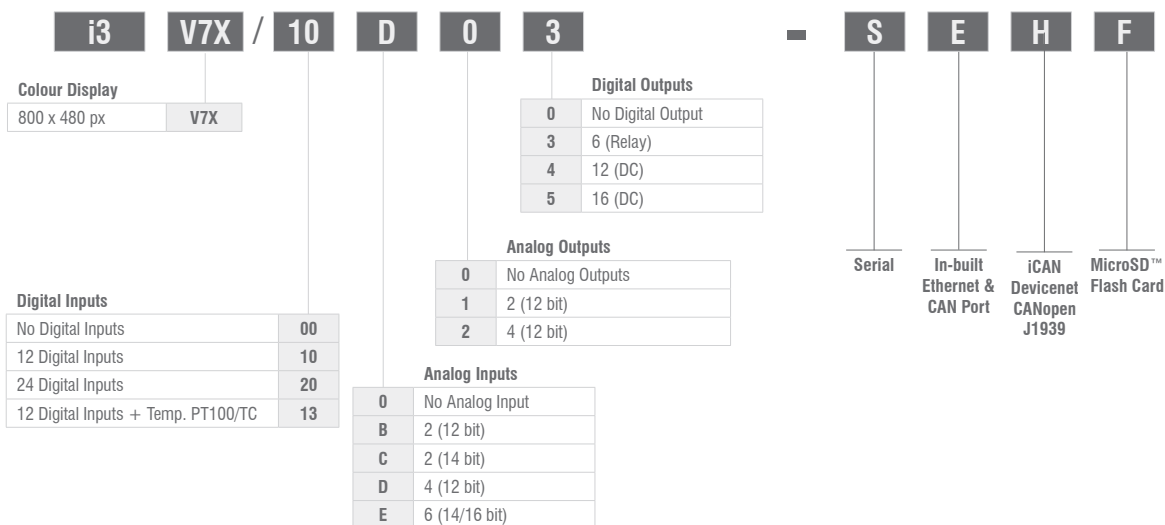

# i<sup>3</sup> Versa 7X Intelligent Control Station



## Technical Specifications

## Technical Datasheet

### General Specifications

Required Power (Steady State)	176mA @ 24VDC, 385mA @ 10VDC
Required Power (Inrush)	25A for <1ms @ 24VDC DC Switched
Primary Voltage Range	10-30VDC
Relative Humidity	5 to 95% Non-Condensing
Clock Accuracy	+/-20 ppm Max. at 25°C (+/-1 minute per month)
Operating Temperature	-10°C to +60°C
Storage Temperature	-20°C to +60°C
Weight	721.2g (without I/O)
Approvals	cUL, UL, CE, FCC
Maximum Current	1100mA
Altitude	Up to 2000m
Pollution Degree	Degree 2 rating

### Control & Logic Specifications

Control Language Support	Advanced Ladder Logic, Full IEC 61131-3
Logic Program Size & Logic Scan Rate	2MB Maximum, 0.02ms/kB
Online Programming Changes	Supported in Advanced Ladder
I/O Support	Digital Inputs - 2048
	Digital Outputs - 2048
	Analogue Inputs - 512
	Analogue Outputs - 512
General Purpose Registers	50,000 (words) Retentive 16,384 (bits) Retentive 16,384 (bits) Non-retentive

### Display Specifications

Display Type	7" WVGA TFT
Resolution	800 x 480 Pixels
Screen Brightness	800cd/m <sup>2</sup> (nits)
Colour	16-bit (65,535 colours)
Screen Memory	17MB
User-Programmable Screens	1023 (max. 1023 objects per screen)
Backlight	LED - 50,000 hours life
Touchscreen Life & Type	1 million touch +; Resistive Type
Screen Update Rate	User configurable within the scan time (perceived as instantaneous in many cases)

### Connectivity

Serial Ports	1 RS-232 & 1 RS-485 on first modular jack (MJ1/2) 1 RS-232 or 1 RS-485 on second modular jack (MJ3)
USB mini-B	USB 2.0 (480MHz) Programming & Data Access
USB A	USB 2.0 (480MHz) for USB Flash Drives (up to 2TB)
CAN	2 x Remote I/O, Peer-to-Peer Comms, i3 Configurator
Ethernet	2 x 10/100MB (Auto-MDX), Modbus TCP, HTTP, FTP, SMTP, i3 Configurator, Ethernet IP, i3-RMI
Remote I/O	IOS, Smart I/O, iSmart
Removable Memory	MicroSD™ (support for 32GB max) Application updates, Datalogging, more
Audio	Line Out

### I/O Specifications

Model	DC In	DC Out	Relays	HS In	HS Out	mA/V In	mA/V RTD/TC	mA/V Out	High Speed Counters	
10D03	12		6	4		4			Number of Counters	2
10B04	12	12		4	2	2			Maximum Frequency	500kHz each
20B05	24	16		4	2	2			Accumulator Size	32-bits each
13C14	12	12		4	2		2	2	Modes Supported	
10E24	12	12		4	2		6*	4*	Totalizer	Quadrature
There are 4 high-speed inputs of the total DC inputs. There are 2 high-speed outputs of the total DC outputs. Model 10D03, 10B04, 20B05 feature 12-bit Analogue I/O. Model 13C14 features 14/16-bit Analogue I/O. High-speed outputs can be used for PWM and Pulse Train Outputs, currently limited to <10kHz and <65kHz for the 10E24 model. Model 10E14 features a 14/17 bit Analogue I/O.									<b>Pulse Measurement</b>	<b>Frequency Measurement</b>
									2 Position Controlled Outputs 1 ON/OFF Setpoint per Output	

\*Up to six mA/V In, RTD/TC, and mA/V Out

### Dimensions & Panel Cutout

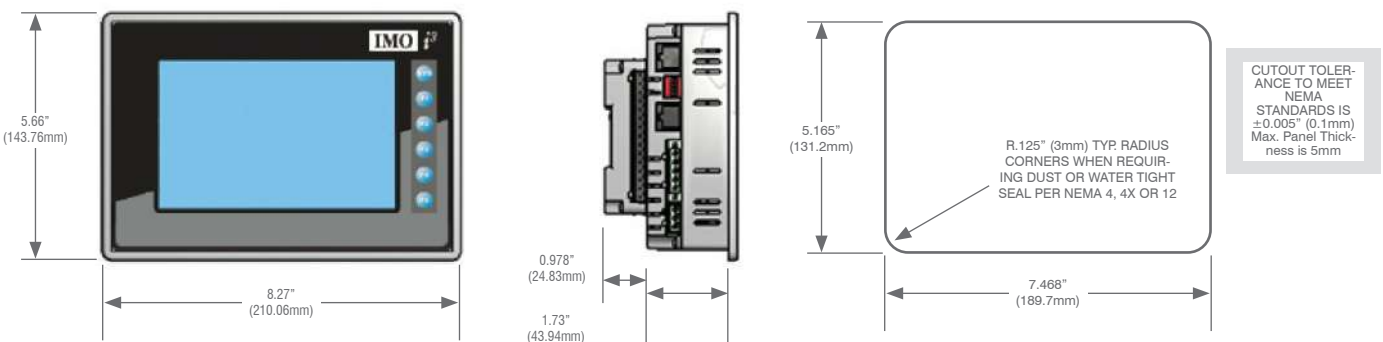

# i<sup>3</sup> Versa 7X Intelligent Control Station



## Ports & Connectors

## Technical Datasheet

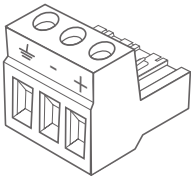

### DC Input / Frame

Torque rating: 4.5-7.0 in/lbs (0.50-0.78Nm)

DC- is internally connected to I/O V-, but is isolated from CAN V-

Class 2 power supply must be used

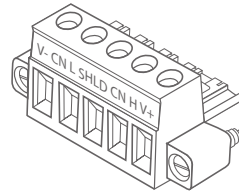

### CAN

Mounting screw torque rating: 4.5 lb-in (0.50Nm)

SHLD and V+ pins are not internally connected to i<sup>3</sup>AX

### Primary Power Port Pins

Pin	Signal	Description
1	Ground	Frame Ground
2	DC -	Power Supply Common
3	DC+	Power Supply Voltage

### Primary Power Port Pins

Pin	Signal	Description	Direction
1	V-	CAN Ground - Black	-
2	CN L	CAN Data Low - Blue	IN / OUT
3	SHLD	Shield Ground - None	-
4	CN H	CAN Data High - White	IN / OUT
5	V+ (NC)	No Connect - Red	



### MJ1/2 Independent Serial Ports

MJ1: RS-232 with Full Handshaking  
MJ2: RS-485 Half-duplex

#### MJ1 Pins

#### MJ2 Pins

Pin	Signal	Direction	Signal	Direction
8	TXD	OUT	-	-
7	RXD	IN	-	-
6	0 V	Ground	0 V	Ground
5	+5V@60mA	OUT	+5V@60mA	OUT
4	RTS	OUT	-	-
3	CTS	IN	-	-
2	-	-	RX- / TX-	IN / OUT
1	-	-	RX+ / TX+	IN / OUT

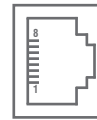

### MJ3 Serial Port

Two multiplexed serial ports on one modular jack (8 posn)

### MJ2 Pins

Pin	Signal	Direction
8	TXD RS-232	OUT
7	RXD RS-232	IN
6	0 V	Ground
5	+5V@60mA	OUT
4	TX- RS-485	OUT
3	TX+ RS-485	OUT
2	RX- (RX- / TX-*) RS-485	IN or IN / OUT
1	RX+ (RX+ / TX+*) RS-485	IN or IN / OUT

\* In half duplex mode

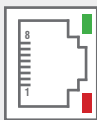

Link Indicator  
Activity Indicator

### Ethernet Communication

10/100 Ethernet port with automatic MDI-X (crossover detection) is provided via the single 8-position modular jack labelled "LAN". Several features are available for use over Ethernet, such as Modbus TCP/IP, Ethernet/IP, SMTP (E-mail), and more.

Modular jack (8 posn RJ45)

Ethernet configuration is done via the i<sup>3</sup> Configurator Hardware Configuration, though temporary Ethernet configuration may be done through the System Menu directly on the i<sup>3</sup>E.

For more information on the Ethernet, available features and protocols, refer to the i<sup>3</sup>E User Manual.

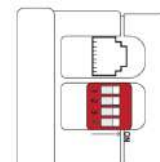

### DIP Switches

Switch	Name	Function	Default
1	RS-485 Termination (MJ3)	ON = Terminated	OFF
2	MJ3 Duplex	ON = Half	OFF
3		OFF = Full	
4	RS-485 Termination (MJ2)	ON = Terminated	OFF

### Built-In I/O

I/O is mapped into i<sup>3</sup> Register space, in three separate areas – Digital/Analogue I/O, High-Speed Counter I/O, and High-Speed Output I/O. Digital/Analogue I/O location is fixed starting at 1, but the High-Speed Counter and High-Speed Output references may be mapped to any open register location. For more details on using the High-Speed Counter and High-Speed Outputs, see the i<sup>3</sup>E User's Manual.

Fixed Address	Digital/Analog I/O Function	i <sup>3</sup> E Model				
		10D03	10B04	20B05	13C14	10E24
%I1	Digital Inputs	1-12	1-12	1-24	1-12	1-12
	Reserved	13-32	13-31	25-31	13-31	13-31
	ESCP Alarm	n/a	32	32	32	32
%Q1	Digital Outputs	1-6	1-12	1-16	1-12	1-12
	Reserved	7-24	13-24	17-24	13-24	13-24
	Analogue Inputs	1-4	1-2	1-2	1-2	1-4:33-38
%AI1	Reserved	5-12	3-12	3-12	3-12	n/a
	Reserved	n/a	1-8	1-8	1-8	1-8
%AQ1	Reserved	n/a	n/a	n/a	9-10	9-12
	Analogue Outputs	n/a	n/a	n/a	9-10	9-12

Reserved areas maintain backward compatibility with other i<sup>3</sup> Controller models

Default Address*	High Speed Counter Function	i <sup>3</sup> E Models
%I1601	Status Bits	1-8
%Q1601	Command Bits	1-32
%AI0401	Accumulator 1&2	1-8
%AQ0401	Preload & Match Values	1-12

\*Starting Address locations for %, %Q, %AI & %AQ may be re-mapped by user

Default Address*	High Speed Output Function	i <sup>3</sup> E Models
%I1617	Status Bits	1-8
%Q**	Command Bits	1-32
n/a	n/a	n/a
%AQ0421	PWM or Pulse Train Parameters	1-20

\*Starting Address locations for %I & %AQ may be re-mapped by user

\*\*Q1-Q2 are part of the Fixed I/O Map. In High Speed Output mode they can be used to initiate a Stepper/PTO Move

# i<sup>3</sup> Versa 7X Intelligent Control Station



## 10D03 I/O Board Specifications

### Technical Datasheet

Digital DC Inputs			Digital Relay Outputs	
Inputs per Module	12 including 4 configurable HSC inputs		Outputs per Module	6 Relay
Commons per Module	1		Commons per Module	6
Input Voltage Range	10-30 VDC		Max. Switching Current per Relay	3A @ 250 VAC, Resistive
Absolute Max. Voltage	35 VDC Max		Max. Total Output Current	5A Continuous
Input Impedance	10 kΩ		Max. Switching Voltage	275 VAC, 30 VDC
Input Current	Positive Logic	Negative Logic	Max. Switched Power	1250 VAC, 150W
Upper Threshold	0.8mA	-1.6mA		
Lower Threshold	0.3mA	-2.1mA	Max. Contact Isolation to Ground	1000 VAC
Max. Upper Threshold	8 VDC		Max. Voltage Drop at Rated Current	0.5V
Max. Lower Threshold	3 VDC		Expected Life (see below for detail)	No Load: 5,000,000 200,000 at rated load
OFF to ON Response	1 ms			
ON to OFF Response	1 ms		Max. Switching Rate	300 CPM at no load 20 CPM at rated load
HSC Max. Switching Rate	10 kHz Totalizer/Pulse, Edges 5 kHz Frequency/Pulse, Width 2.5 kHz Quadrature		Type	Mechanical Contact
			Response Time	One update per ladder scan plus 10ms

Analogue Inputs, Medium Resolution				
Number of Channels	4		Input Ranges	0-10 VDC, 0-20 mA, 4-20 mA
Safe Input Voltage Range	-0.5V to 12V		Input Impedance (clamped @ -0.5VDC to 12VDC)	Current Mode: 100 Ω Voltage Mode: 500 kΩ
Nominal Resolution	12 Bits		%AI Full Scale	32,000
Max. Over Current	35 mA		Conversion Speed	Once per Ladder Scan
Max. Error at 25°C (excluding zero)	4-20 mA	1.00% of FS	Filtering	160 Hz hash (noise) filter 1-128 scan digital running average filter
Adjusting filtering may tighten	0-20 mA	1.00% of FS		
	0-10 VDC	1.50% of FS		

J1 (Orange)	Name
I1	IN1
I2	IN2
I3	IN3
I4	IN4
I5	IN5
I6	IN6
I7	IN7
I8	IN8
H1	HSC1 / IN9
0V	Common
A1	Analogue IN1
A2	Analogue IN2
A3	Analogue IN3
A4	Analogue IN4
0V	Common

Orange - Digital In / Analog In

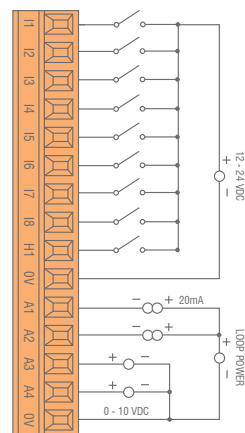

J2 (Black)	Name
C6	Relay 6 COM
R6	Relay 6 NO
C5	Relay 5 COM
R5	Relay 5 NO
C4	Relay 4 COM
R4	Relay 4 NO
C3	Relay 3 COM
R3	Relay 3 NO
C2	Relay 2 COM
R2	Relay 2 NO
C1	Relay 1 COM
R1	Relay 1 NO
H4	HSC4 / IN12
H3	HSC3 / IN11
H2	HSC2 / IN10

Black - Relay Out / Digital In

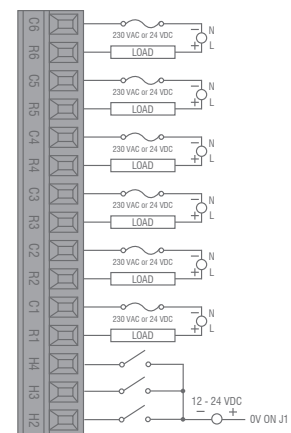

Location of I/O jumpers (JP1 & JP2) and wiring connectors (J1 and J2) with back cover removed.

### Model 2 Jumper Setting Details

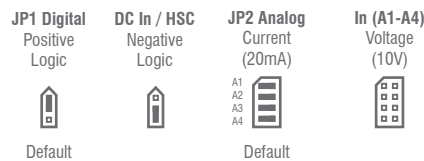

**Note:** The Module Setup configuration must match the selected I/O (JP) jumper settings.

**Note:** When using JP2 (A1-A4), each channel can be independently configured.

### Relay Life Expectancy

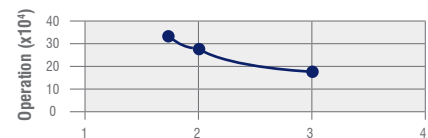

**WARNING:** Exposure to some chemicals may degrade the sealing properties of materials used in the Tyco relay PCJ

Cover / case & base: Mitsubishi Engineering Plastics Corp. 5010GN6-30 or 5010GN6-30 M8 (PBT)  
Sealing material: Kishimoto 4616-50K (1 part epoxy resin)

It is recommended to periodically inspect the relay for any degradation of properties and replace if degradation is found.

# i<sup>3</sup> Versa 7X Intelligent Control Station



## 10B04 & 20B05 I/O Board Specifications

### Technical Datasheet

Digital DC Inputs	10B04	20B05	Digital DC Outputs	10B04	20B05
Inputs per Module	12 including 4 configurable HSC inputs	24 including 4 configurable HSC inputs	Outputs per Module	12 including 2 configurable PWM outputs	16 including 2 configurable PWM outputs
Commons per Module	1		Commons per Module	1	
Input Voltage Range	10-30 VDC		Output Type	Sourcing / 10 K Pull-Down	
Absolute Max. Voltage	35 VDC Max		Absolute Max. Voltage	28 VDC Max	
Input Impedance	10 kΩ		Output Protection	Short Circuit	
Input Current	Positive Logic	Negative Logic	Max. Output Current per Point	0.5 A	
Upper Threshold	0.8mA	-1.6mA	Max. Total Current	4 A Continuous	
Lower Threshold	0.3mA	-2.1mA	Max. Output Supply Voltage	30 VDC	
Max. Upper Threshold	8 VDC		Min. Output Supply Voltage	10 VDC	
Max. Lower Threshold	3 VDC		Max. Voltage Drop at Rated Current	0.25V	
OFF to ON Response	1 ms		Max. Inrush Current	650 mA per channel	
ON to OFF Response	1 ms		Min. Load	None	
HSC Max. Switching Rate	500 kHz each		OFF to ON Response	1 ms	
ON to OFF Response	1 ms		Output Characteristics	Current Sourcing (Pos Logic)	

Analogue Inputs, Medium Resolution					
Number of Channels	2		Input Ranges	0-10 VDC, 0-20 mA, 4-20 mA	
Safe Input Voltage Range	-0.5V to 12V		Input Impedance (clamped @ -0.5VDC to 12VDC)	Current Mode: 100 Ω	Voltage Mode: 500 kΩ
Nominal Resolution	12 Bits		%AI Full Scale	32,000	
Max. Over Current	35 mA		Conversion Speed	Once per Ladder Scan	
Max. Error at 25°C (excluding zero)	4-20 mA 1.00% of FS	0-20 mA 1.00% of FS	Filtering	160 Hz hash (noise) filter 1-128 scan digital running average filter	
Adjusting filtering may tighten	0-10 VDC 1.50% of FS				

J1 (Orange)	Name
I1	IN1
I2	IN2
I3	IN3
I4	IN4
I5	IN5
I6	IN6
I7	IN7
I8	IN8
H1	HSC1 / IN9
H2	HSC2 / IN10
H3	HSC3 / IN11
H4	HSC4 / IN12
A1	Analogue IN1
A2	Analogue IN2
0V	Common

Orange - Digital In / Analog In

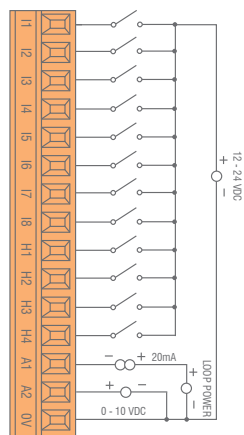

J3 (Orange)	20B05
I13	IN13
I14	IN14
I15	IN15
I16	IN16
I17	IN17
I18	IN18
I19	IN19
I20	IN20
I21	IN21
I22	IN22
I23	IN23
I24	IN24
0V	Common

Orange - Positive Logic Digital In

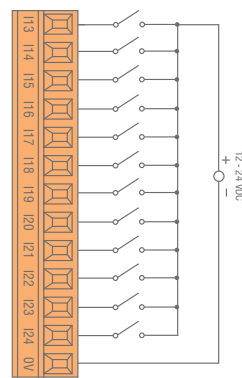

J4 (Orange)	20B05
Q16	OUT16
Q15	OUT15
Q14	OUT14

Orange - Positive Logic Digital Out

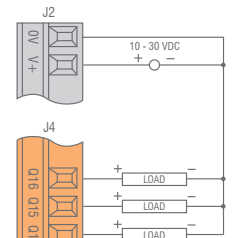

J2 (Black)	10B04	20B05
0V	Common	
V+	V+	
NC (Q13)	No Connect	OUT13
Q12	OUT12	
Q11	OUT11	
Q10	OUT10	
Q9	OUT9	
Q8	OUT8	
Q7	OUT7	
Q6	OUT6	
Q5	OUT5	
Q4	OUT4	
Q3	OUT3	
Q2	OUT2 / PWM2	
Q1	OUT1 / PWM1	

Black - Positive Logic Digital Out

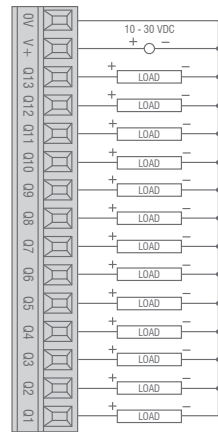

### Jumper Setting Details

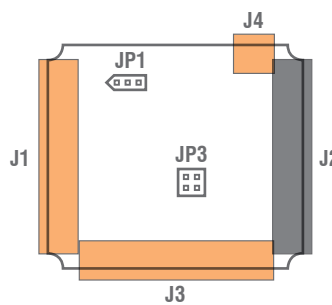

Location of I/O jumpers (JP1 & JP3) and wiring connectors (J1, J2, J3 & J4) with back cover removed.

### JP1 Digital DC Inputs

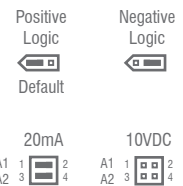

Note: The Module Setup configuration must match the selected I/O (JP) jumper settings.

Note: When using JP3 (A1-A2), each channel can be independently configured.

NOTE: 10B04 uses J1 & J2 only. 20B05 uses J1, J2, J3 & J4

# i<sup>3</sup> Versa 7X Intelligent Control Station



## Technical Datasheet

### 13C14 I/O Board Specifications

Digital DC Inputs		Digital DC Outputs	
Inputs per Module	12 including 4 configurable HSC inputs	Outputs per Module	12 including 2 configurable PWM outputs
Commons per Module	1	Commons per Module	6
Input Voltage Range	10-30 VDC	Output Type	Sourcing / 10 K Pull-Down
Absolute Max. Voltage	35 VDC Max	Absolute Max. Voltage	28 VDC Max
Input Impedance	10 kΩ	Output Protection	Short Circuit
Input Current	Positive Logic 0.8mA Negative Logic -1.6mA -2.1mA	Max. Output Current per Point	0.5A
Upper Threshold		Max. Total Current	4 A Continuous
Lower Threshold		Max. Output Supply Voltage	30 VDC
Max. Upper Threshold	8 VDC	Min. Output Supply Voltage	10 VDC
Max. Lower Threshold	3 VDC	Max. Voltage Drop at Rated Current	0.25V
OFF to ON Response	1 ms	Max. Inrush Current	650 mA per channel
ON to OFF Response	1 ms	Min. Load	None
HSC Max. Switching Rate	10 kHz Totalizer/Pulse, Edges 5 kHz Frequency/Pulse, Width 2.5 kHz Quadrature	OFF to ON Response	1 ms
		ON to OFF Response	1 ms
		Output Characteristics	Current Sourcing (Positive Logic)

Analogue Inputs, High Resolution			
Number of Channels	2	Thermocouple	Temperature Range
Input Ranges (Selectable)	0 - 10 VDC, 0 – 20 mA, 4 – 20 mA, 100mV PT100 RTD, and J, K, N, T, E, R, S, B Thermocouple	B / R / S E T J K / N	2912°F to 32.0°F (1600°C to 0°C) 1652°F to -328°F (900°C to -200°C) 752.0°F to -400°F (400°C to -240°C) 1382.0°F to -346.0°F (750°C to -210°C) 2498.0°F to -400°F (1370°C to -240°C)
Nominal Resolution	10V, 20mA, 100mV: 14 Bits RTD, Thermocouple: 16 Bits	Thermocouple Common Mode Range	±10V
Converter Type	Delta Sigma	Max. Thermocouple Error	±0.2% (±0.3% below -100°C)
Input Impedance (Clamped @ -0.5 VDC to 12 VDC)	Current Mode: 100 Ω, 35mA Max. Continuous Voltage Mode: 500 kΩ, 35mA Max. Continuous	Max. Error at 25°C (*excluding zero)	4-20 mA ±0.10% *0-20 mA ±0.10% *0-10 VDC ±0.10% RTD (PT100) ±1.0°C 0-100 mV ±0.05%
AI Full Scale	10 V, 20 mA, 100 mV: 32,000 counts full scale. RTD / T/C: 20 counts / °C	Conversion Speed, Both Channels Converted	10V, 20mA, 100mV: 30 Times/Second RTD, Thermocouple: 7.5 Times/Second
Max. Over-Current	35mA	Conversion Time per Channel	10V, 20mA, 100mV: 16.7mS RTD, Thermocouple: 66.7mS
Open Thermocouple Detect Current	50mA	RTD Excitation Current	250 μA

Analogue Outputs			
Number of Channels	2	Minimum Current Load	500Ω
Output Ranges	0-10VDC, 0-20mA, 4-20mA	Galvanic Isolation	None
Nomimnal Resolution	12 Bits	Conversion Speed	Min. all channels once per scan
Response Time	One update per ladder scan		
Max. Error at 25°C (excluding zero)	0-20mA 0.1% of FS 0-10V 0.1% of FS	Additional Error for temperatures other than 25°C	20mA 0.0126%/°C

# i<sup>3</sup> Versa 7X Intelligent Control Station



Technical Datasheet

## 13C14 I/O Board Specifications continued

J1 (Orange)	Name
I1	IN1
I2	IN2
I3	IN3
I4	IN4
I5	IN5
I6	IN6
I7	IN7
I8	IN8
H1	HSC1 / IN9
H2	HSC2 / IN10
H3	HSC3 / IN11
H4	HSC4 / IN12
NC	No Connect
NC	No Connect
0V	Common

Orange - Positive Logic Digital Inputs

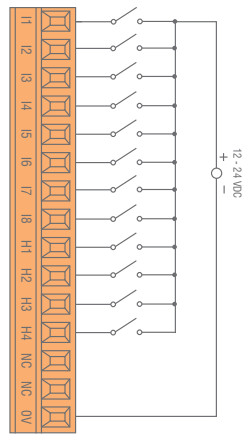

J2 (Black)	Name
0V	Common
V+	Output Power
NC	No Connect
Q12	OUT12
Q11	OUT11
Q10	OUT10
Q9	OUT9
Q8	OUT8
Q7	OUT7
Q6	OUT6
Q5	OUT5
Q4	OUT4
Q3	OUT3
Q2	OUT2 / PWM2
Q1	OUT1 / PWM1

Black - Positive Logic Digital Out

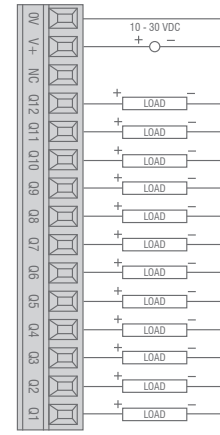

J3 (Orange)	Name
T1+	TC (1+) or RTD (1+) or 100mV (1+)
T1-	TC (1-) or RTD (1-) or 100mV (1-)
T2+	TC (2+) or RTD (2+) or 100mV (2+)
T2-	TC (2-) or RTD (2-) or 100mV (2-)
AQ1	10V or 20mA Out (1)
AQ2	10V or 20mA Out (2)
0V	Common
MA1	0-20mA In (1)
V1	0-10V In (1)
0V	Common
MA2	0-20mA In (2)
V2	0-10V In (2)
0V	Common

0-10V Analog In

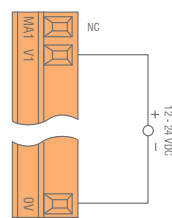

mV In

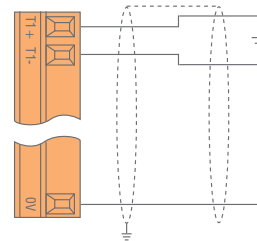

RTD In

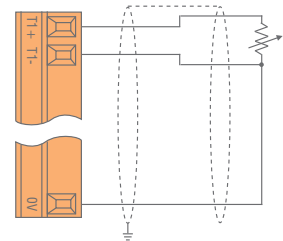

20mA Analog In

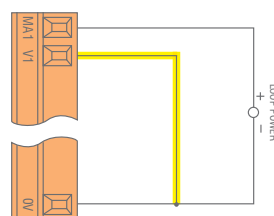

**NOTE:** Be sure to wire 0V to V1 as shown for proper operation

Thermocouple In

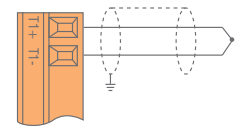

**NOTE:** Loop power requirements are determined by the transmitter specification.

4 - 20mA Analog Out

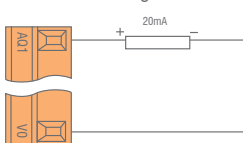

0 - 10V Analog Out

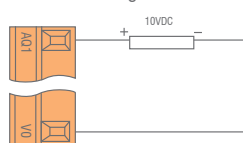

### Jumper Setting Details

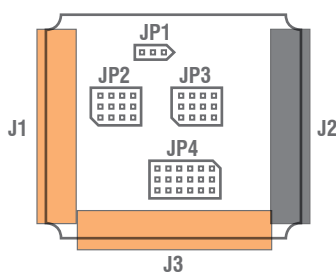

Location of I/O jumpers (JP1 - JP4) and wiring connectors (J1 - J3) with back cover removed.

#### JP1 Digital DC Inputs



#### JP2 & JP3 Analog Inputs Setting

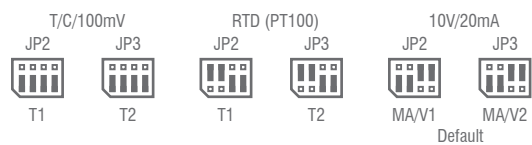

#### JP4 Analog Output Setting Voltage or Current



# i<sup>3</sup> Versa 7X Intelligent Control Station



## Technical Datasheet

### 10E24 I/O Board Specifications

Digital DC Inputs			Digital DC Outputs	
Inputs per Module	12		Outputs per Module	12
Commons per Module	1		Commons per Module	1
Input Voltage Range	10-30 VDC		Output Type	Sourcing / 10 K Pull-Down
Absolute Max. Voltage	35 VDC Max		Absolute Max. Voltage	30 VDC Max
Input Impedance	10 kΩ		Output Protection	Short Circuit & Overvoltage
Input Current	Positive Logic	Negative Logic	Max. Output Current per Point	0.5A
Upper Threshold	0.8mA	-1.6mA	Max. Total Current per driver	2 A Continuous
Lower Threshold	0.3mA	-2.1mA	Max. Output Supply Voltage	30 VDC
Min. "On" Input	8 VDC		Min. Output Supply Voltage	10 VDC
Max. "Off" Input	3 VDC		Max. Voltage Drop at Related Current	0.25 VDC
Galvanic Isolation	None		I/O Indication	None
OFF to ON Response	1 ms		Galvanic Isolation	None
ON to OFF Response	1 ms		Min. Load	None
Logic Polarity	Positive and Negative based on Common pin level.		OFF to ON Response	150 ns
I/O Indication	None		ON to OFF Response	150 ns
High Speed Counter Inputs	4 - DIN 8-12		PWM Out	500kHz
High Speed Counter Max. Frequency	500kHz		Output Characteristics	Current Sourcing (Positive Logic)
Connector Type	3.5mm Pluggable cage clamp connector			

Analogue Inputs, High Resolution			
Number of Channels	6	Absolute Max. Input Voltage	-0.5 to 12V DC
Input Range	0-20mA, 4-20 mA dc. 0-60mV, 0-10V dc. TC - J, K, N, T, E, R, S, B RTD - PT100, PT1000	Input Impedance (Clamped @ -0.5 to 10.23VDC).	TC / RTD / mV > 2 MΩ mA: 15 Ω + 1.5 V V: 1.1 MΩ
Nominal Resolution	14 - 17 Bits (variable depending on input type)	Galvanic Isolation	None

Sensor Range and Accuracy	Input Type	Range	Accuracy
	TC J	-120°C to 1000°C / -184°F to 1832°F	± 0.2% FS ± 1°C
	TC K	-130°C to 1372°C / -202°F to 2501.6°F	± 0.2% FS ± 1°C
	TC T	-130°C to 400°C / -202°F to 752°F	± 0.2% FS ± 1°C
	TC E	-130°C to 780°C / -202°F to 1436°F	± 0.2% FS ± 1°C
	TC N	-130°C to 1300°C / -202°F to 2372°F	± 0.2% FS ± 1°C
	TC R, S	20°C to 1768°C / 68°F to 3214.4°F	± 0.2% FS ± 3°C
	TC B	100°C to 1820°C / 212°F to 3308°F	± 0.2% FS ± 3°C
	PT100/1000	-200°C to 850°C / -328°F to 1562°F	± 0.15% FS
	0-20mA	0-20mA	± 0.15% FS
	0-60mV	0-60mV	± 0.15% FS
0-10V	0-10V	± 0.15% FS	
Conversion Speed	Minimum all channels converted in approx. 150mS		

Analogue Outputs			
Number of Channels	4	Minimum Current Load	500Ω
Output Ranges	0-10VDC, 0-20mA, 4-20mA	Galvanic Isolation	None
Nominal Resolution	12 Bits	Conversion Speed	Min. all channels once per scan
Response Time	One update per ladder scan		
Max. Error at 25°C (excluding zero)	0-20mA 0.1% of FS 0-10V 0.1% of FS	Additional Error for temperatures other than 25°C	20mA 0.0126%/°C

# i<sup>3</sup> Versa 7X Intelligent Control Station



Technical Datasheet

## 10E24 I/O Board Specifications continued

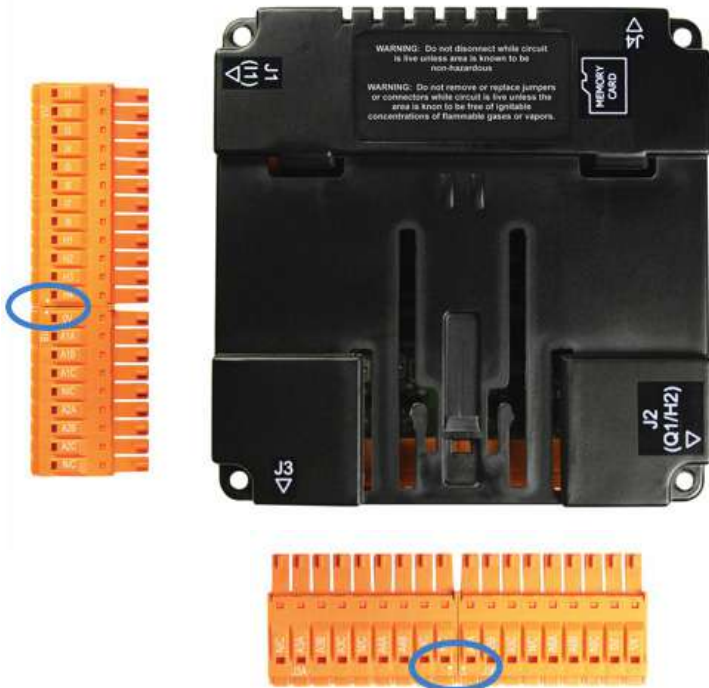

For ease of operability, the high density terminals are divided into more manageable pairs of connectors (J1A + J1B, J2A + J2B, J3A + J3B)

To ensure proper installation, connector symbols must match as seen below:

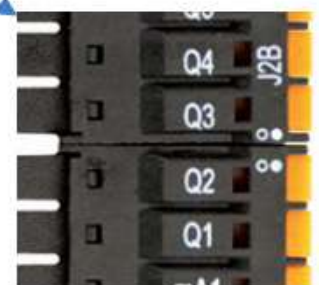

J1 (Orange/Green)		Name
J1A	I1	IN1
	I2	IN2
	I3	IN3
	I4	IN4
	I5	IN5
	I6	IN6
	I7	IN7
	I8	IN8
J1B	H1	HSC1 / IN9
	H2	HSC2 / IN10
	H3	HSC3 / IN11
	H4	HSC4 / IN12
	0V	Common
	A1A	Univ. AI 1 pin 1
	A1B	Univ. AI 1 pin 2
	A1C	Univ. AI 1 pin 3
	NC	No Connect
	A2A	Univ. AI 2 pin 1
	A2B	Univ. AI 2 pin 2
	A2C	Univ. AI 2 pin 3
NC	No Connect	

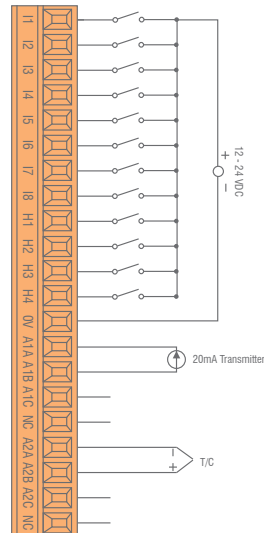

J2 (Black/Green)		Name
J2A	V3	V OUT 3*
	V2	V OUT 2*
	V1	V OUT 1*
	mA4	mA Out 4*
	mA3	mA Out 3*
	mA2	mA Out 2*
	mA1	mA Out 1*
	Q1	OUT 1 / PWM1
	Q2	OUT 2 / PWM2
	Q3	OUT 3
	Q4	OUT 4
	Q5	OUT 5
J2B	Q6	OUT 6
	Q7	OUT 7
	Q8	OUT 8
	Q9	OUT 9
	Q10	OUT 10
	Q11	OUT 11
	Q12	OUT 12
	V+	V External +
0V	Common	

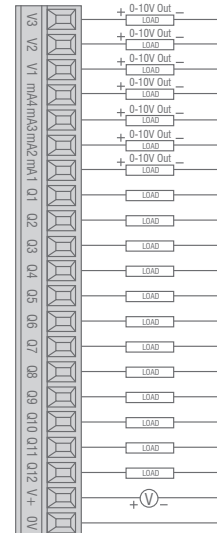

J3 (Orange/Green)		Name
Univ. AI	NC	No Connect
	A3A	Univ. AI 3 pin 1
	A3B	Univ. AI 3 pin 2
	A3C	Univ. AI 3 pin 3
	NC	No Connect
	A4A	Univ. AI 4 pin 1
Univ. AI	A4B	Univ. AI 4 pin 2
	A4C	Univ. AI 4 pin 3
	NC	No Connect
	A5A	Univ. AI 5 pin 1
	A5B	Univ. AI 5 pin 2
	A5C	Univ. AI 5 pin 3
Univ. AI	NC	No Connect
	A6A	Univ. AI 6 pin 1
	A6B	Univ. AI 6 pin 2
	A6C	Univ. AI 6 pin 3
	NC	No Connect
	V4	V OUT 4*

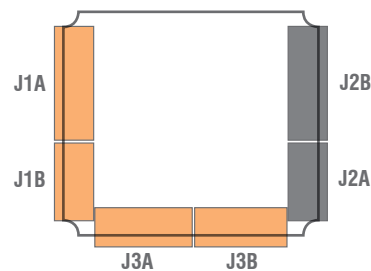
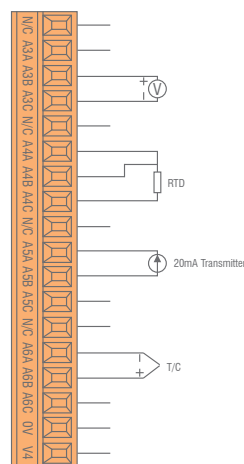

NOTE: \* Both mA & V outputs are active for each output channel, however, only the configured output type is calibrated (maximum 4 channels simultaneously).

## 10E24 I/O Board Specifications continued

### Example of Universal Input Wiring Schematic

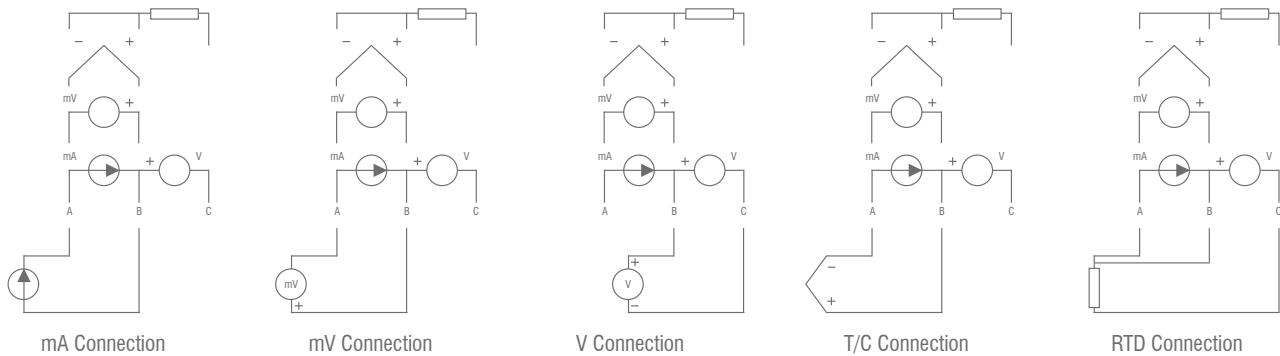

### Configuration

The data registers as follows:-

Digital Inputs	Digital Outputs	Analogue Inputs	Analogue Outputs
%I1-12	%Q1-12	%AI1-4, %AI33-38	%AQ9-12

**NOTE:** The first four Analogue inputs are mapped to both %AI1-4 and %AI33-36, analogue input channels 5 & 6 are mapped to %AI37 and %AI38 respectively only.

### Data Values

The analog inputs return data types as follows:

Input Mode	Data Format	Comment
0-20mA, 4-20mA	0-32000	
0-10V, 0-60mV	0-32000	
TC, RTD	Temperature in °C or °F to 1 decimal place xxx.y	°C or °F may be selected in the I/O config section. The value is an integer, the user should divide by 10.

### Status Register

Register	Descriptions							
%R1	Bit-wise status register enable – R1.1 – R1.9 enable for registers R2 to R9							
%R2	Firmware version							
%R3	Watchdog count – cleared on power-up.							
%R4	Status bits -				16...4	3	2	1
					Reserved	Normal	Config	Calibration
%R5	Scan rate of the 10E24 board (average) in units of 100µS.							
%R6	Scan rate of the 10E24 board (max) in units of 100µS.							
%R7	Channel Status	Channel 2			Channel 1			
	8	7	6	5	4	3	2	1
	Open RTD	Out of Limits	Shorted RTD	Open TC	Open RTD	Out of Limits	Shorted RTD	Open TC
%R8	Channel Status	Channel 4			Channel 3			
	8	7	6	5	4	3	2	1
	Open RTD	Out of Limits	Shorted RTD	Open TC	Open RTD	Out of Limits	Shorted RTD	Open TC
%R9	Channel Status	Channel 6			Channel 5			
	8	7	6	5	4	3	2	1
	Open RTD	Out of Limits	Shorted RTD	Open TC	Open RTD	Out of Limits	Shorted RTD	Open TC
%R10-14	Reserved							

**NOTE:** For the purposes of the example, the block is shown starting at %R1, but it can be set to anywhere in the %R memory map.

# i<sup>3</sup> Versa 7X Intelligent Control Station

# IMO

## Technical Datasheet

### EN Safety

**WARNING:** Battery may explode if mistreated. Do not recharge, disassemble or dispose of in fire.

**WARNING: EXPLOSION HAZARD - BATTERIES MUST ONLY BE CHANGED IN AN AREA KNOWN TO BE NON-HAZARDOUS**

This equipment is suitable for use in Class 1, Division 2, Groups A, B, C and D or Non-hazardous locations only.

#### FOR U.S. & CANADA ONLY

Power input and output (I/O) wiring must be in accordance with Class 1, Division 2 wiring methods of the National Electric Code, NFPA70 for installations in the U.S. or as specified in Section 18-1J2 of the Canadian Electric Code for installations within Canada and in accordance with the authority having jurisdiction.

**WARNING: EXPLOSION HAZARD - Do not disconnect equipment unless power has been switched off or the area is known to be non-hazardous.**

**WARNING: EXPLOSION HAZARD - Substitution of components may impair suitability for Class 1, Division 2.**

Digital outputs shall be supplied from the same source as the i3 Controller.

**WARNING:** To reduce the risk of fire, electrical shock, or physical injury it is strongly recommended to fuse all Power Sources connected to the i3 controller. Be sure to locate fuses as close to the source as possible.

### FR Sécurité

**AVERTISSEMENT:** la batterie peut exploser si elle est malmenée, endommagée. Ne pas recharger, démonter ou jeter au feu.

**AVERTISSEMENT: RISQUE D'EXPLOSION - les Piles ne doivent être changées que dans un endroit sûr (Non Dangereux) respectant les règles de sécurité.**

Cet équipement est conçu pour être utilisé uniquement dans des emplacements de classe 1, division 2, groupes A, B, C et D ou non dangereux.

#### POUR LES ÉTATS-UNIS ET LE CANADA SEULEMENT

Le câblage d'entrée et de sortie d'alimentation (E / S) doit être conforme à la classe 1, Division 2 méthodes de câblage du National Electric Code, NFPA70 pour installations situées aux États-Unis ou telles que spécifiées à l'article 18-1J2 du Code canadien de l'électricité pour les installations situées au Canada et en conformité avec les autorités compétentes.

**AVERTISSEMENT: RISQUE D'EXPLOSION - Ne débranchez pas l'équipement si le courant n'a pas été coupé ou que l'endroit est connu pour être non dangereux.**

**AVERTISSEMENT: RISQUE D'EXPLOSION - La substitution de composants peut compromettre le respect des normes de Classe 1 et Division 2.**

Les sorties numériques doivent provenir de la même source que le contrôleur i3.

**AVERTISSEMENT:** Pour éviter tout risque de choc électrique ou de brûlure, connectez toujours la terre de sécurité avant de faire d'autres connexions.

**WARNING:** Only qualified electrical personnel familiar with the construction and operation of this equipment and the hazards involved should install, adjust, operate, or service this equipment. Read and understand this manual and other applicable manuals in their entirety before proceeding. Failure to observe this precaution could result in severe bodily injury or loss of life.

**WARNING:** To avoid the risk of electric shock or burns, always connects the earth ground before making any other connections.

**WARNING:** Replace fuse with the same type and rating to provide protection against risk of fire and shock hazards.

**WARNING:** In the event of repeated failure, do not replace the fuse again as a repeated failure indicates a defective condition that will not clear by replacing the fuse.

Jumpers on connector JP1 and others shall not be removed or replaced while the circuit is live unless the area is known to be free of ignitable concentrations of flammable gases or vapours.

**WARNING:** Use caution when connecting controllers to PCs via serial or USB. PCs and especially laptops may use 'floating power supplies' that are ungrounded. This can cause a voltage potential between the laptop and controller. Make sure the controller and laptop are grounded for maximum protection or use an isolated serial or USB cable.

**AVERTISSEMENT:** Pour réduire les risques d'incendie, de choc électrique ou de blessure, il est fortement recommandé pour fusionner les entrées de mesure de tension. Assurez-vous de placer les fusibles le plus près possible de la source.

**AVERTISSEMENT:** Remplacez le fusible avec le même type et le même calibre pour vous protéger contre le risque d'incendie etrisques d'électrocution.

**AVERTISSEMENT:** En cas de défaillance répétée, ne remplacez PAS le fusible à nouveau, car une défaillance répétée indique condition défectueuse qui ne sera pas effacer en remplaçant le fusible.

**AVERTISSEMENT:** Seul du personnel électrique qualifié et familiarisé avec la construction et le fonctionnement de ce l'équipement et les risques encourus devraient installer, ajuster, utiliser ou réparer cet équipement. Lisez et comprenez ce manuel et les autres manuels applicables dans leur intégralité avant de en cours.

Le non-respect de cette précaution pourrait entraîner des lésions corporelles graves ou la perte de la vie.

**AVERTISSEMENT:** Soyez prudent lorsque vous connectez des contrôleurs à des PC via une connexion série ou USB. Les ordinateurs, en particulier les ordinateurs portables, peuvent utiliser des 'alimentations flottantes' non mises à la terre. Cela peut provoquer un potentiel de tension entre l'ordinateur portable et le contrôleur. Assurez-vous que le contrôleur et l'ordinateur portable sont mis à la terre pour une protection maximale ou utilisez un câble série ou USB isolé.

## Common Cause of Analog Input Tranzorb Failure

If a 4-20mA circuit is initially wired with loop power, but without a load, the analogue Input could see 24VDC. This is higher than the rating of the tranzorb. This can be solved by NOT connecting loop power prior to load connection, or by installing a low-cost PTC in series between the load and analogue input.

