

LPS Series 10W to 90W AC-DC DIN Rail Power Supplies



Key Features

- 5, 12 & 24 VDC
- Universal Input: 85-264VAC / 120-370VDC
- High Efficiency
- Short Circuit Protection
- Internal Input Filter
- IP20 Protection Rated
- Class 2



Technical Specification

Model	LPS-1-010-24DC	LPS-1-024-24DC	LPS-1-030-5DC	LPS-1-040-12DC
Input Voltage	85-264VAC / 120-370VDC			
Output Wattage	10W	24W	30W	40W
Output Voltage	24VDC	24VDC	5VDC	12VDC
Output Current	0.42A	1A	6A	3.33A
Efficiency	84%		78%	86%
General Specification				
Approval	cURus - Class 2			
Isolation Voltage	3000VAC/4242VDC			
Isolation Resistance	100MΩ @ 500VDC			
Ambient Temperature	-30 to +70°C (refer to derating curve)			
Derating	(50 to 70°C) 2.5%/°C			
Storage Temperature	-40 to +85°C			
Relative Humidity	20 to 95% RH			
Cooling	Free air convection			
Dimensions	92 x 23 x 100mm		92 x 41 x 100mm	
Weight	140g	150g	280g	
Case Material	Plastic			
Input Specifications				
Rated Input Voltage	85-264VAC / 120-370VDC			
Line Frequency	50/60Hz			
Inrush Current (115 / 230VAC)	35 / 70A		30 / 60A	
Output Specifications				
Output Voltage Accuracy	+1%			
Minimum Load	0%			
Line Regulation	±1%			
Load Regulation	±5%			
Turn On Time	500ms			
Voltage Fall Time	150ms			
Voltage Rise Time	30ms			
Hold Up Time (115 / 230VAC)	30 / 30ms			
Ripple & Noise	150mVp-p		80mVp-p	120mVp-p
Voltage Trim Range	21.6-28.8VDC		4.5-5.75VDC	21.6-28.8VDC
DC ON & LOW Indicator (Green & Red LED)	18-21.6VDC		3.5-4.5VDC	18-21.6VDC
Control & Protection				
Rated Overload Protection	> 105%-150%			
Over Voltage Protection	27.6-32.4VDC		6.25-7.25VDC	15.6-18VDC
Output Short Circuit	Hiccup Mode			

LPS Series 10W to 90W AC-DC DIN Rail Power Supplies



Key Features

- 5, 12 & 24 VDC
- Universal Input: 85-264VAC / 120-370VDC
- High Efficiency
- Short Circuit Protection
- Internal Input Filter
- IP20 Protection Rated
- Class 2



Technical Specification

Model	LPS-1-040-24DC	LPS-1-060-12DC	LPS-1-060-24DC	LPS-1-090-12DC
Input Voltage	85-264VAC / 120-370VDC			
Output Wattage	40W	60W	60W	90W
Output Voltage	24VDC	12VDC	24VDC	12VDC
Output Current	1.7A	5A	2.5A	7.5A
Efficiency	88%	86%	88%	83%
General Specification				
Approval	cURus - Class 2			
Isolation Voltage	3000VAC/4242VDC			
Isolation Resistance	100MΩ @ 500VDC			
Ambient Temperature	-30 to +70°C (refer to derating curve)			
Derating	(50 to 70°C) 2.5%/°C			
Storage Temperature	-40 to +85°C			
Relative Humidity	20 to 95% RH			
Cooling	Free air convection			
Dimensions	92 x 41 x 100mm			92 x 55 x 100mm
Weight	280g			400g
Case Material	Plastic			
Input Specifications				
Rated Input Voltage	85-264VAC / 120-370VDC			
Line Frequency	50/60Hz			
Inrush Current (115 / 230VAC)	30 / 60A			
Output Specifications				
Output Voltage Accuracy	+1%			
Minimum Load	0%			
Line Regulation	±1%		±2%	±1%
Load Regulation		±5%		±1%
Turn On Time	500ms			
Voltage Fall Time	150ms			
Voltage Rise Time	30ms			
Hold Up Time (115 / 230VAC)	30 / 30ms			
Ripple & Noise	150mVp-p	120mVp-p	150mVp-p	120mVp-p
Voltage Trim Range	21.6-28.8VDC	10.8-13.8VDC	21.6-28.8VDC	10.8-13.8VDC
DC ON & LOW Indicator (Green & Red LED)	18-21.6VDC	9-10.8VDC	18-21.6VDC	9-10.8VDC
Control & Protection				
Rated Overload Protection	> 105%-150%			
Over Voltage Protection	31.2-36VDC	15.6-18V	31.2-36VDC	15.6-18V
Output Short Circuit	Hiccup Mode			

LPS Series 10W to 90W AC-DC DIN Rail Power Supplies



Dimensions (mm)

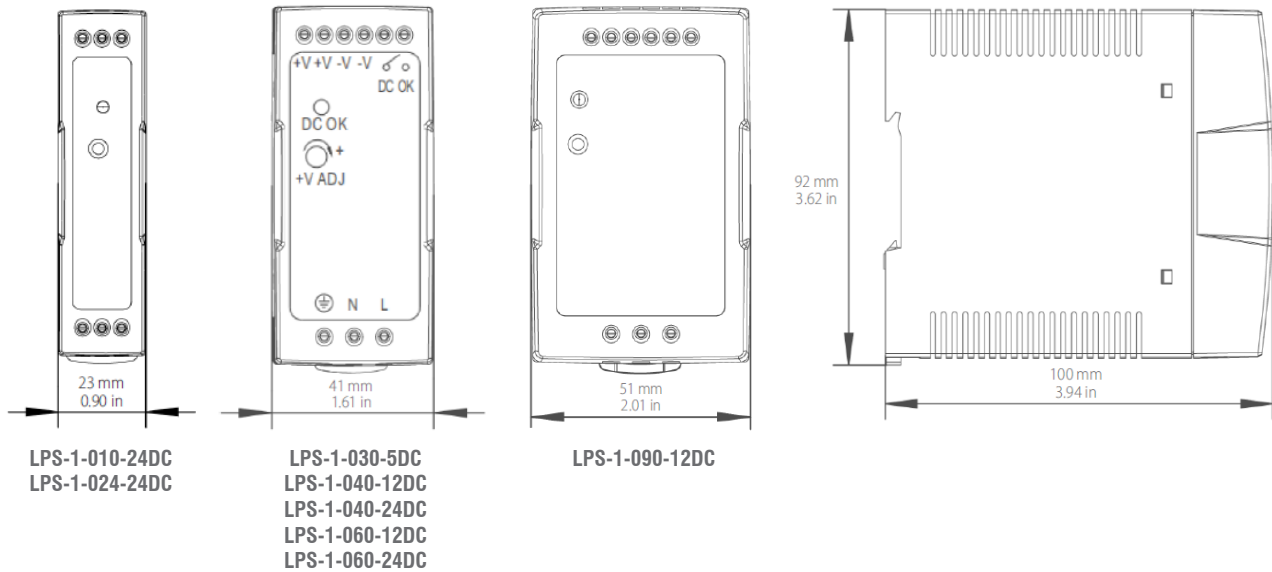

Derating Curves

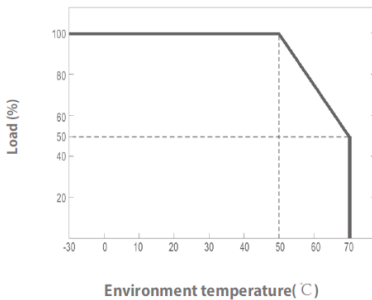

LPS-1-010-24DC
LPS-1-024-24DC
LPS-1-030-5DC
LPS-1-040-12DC
LPS-1-040-24DC

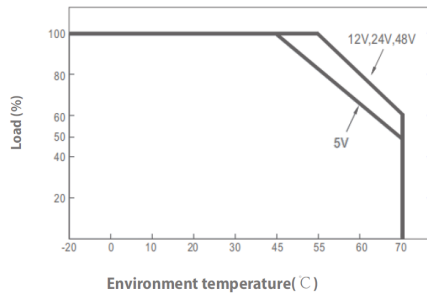

LPS-1-060-12DC
LPS-1-060-24DC

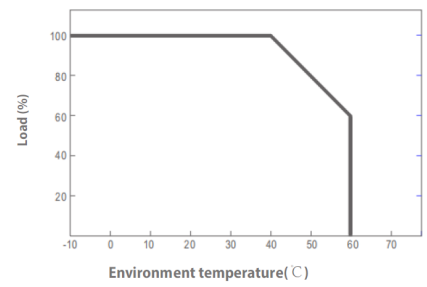

LPS-1-090-12DC

Minus Output & Input Curves

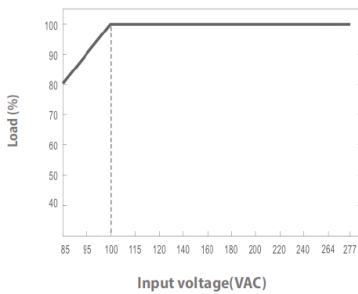

LPS-1-010-24DC
LPS-1-024-24DC
LPS-1-030-5DC
LPS-1-040-12DC
LPS-1-040-24DC

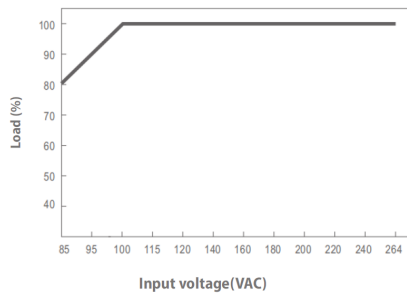

LPS-1-060-12DC
LPS-1-060-24DC

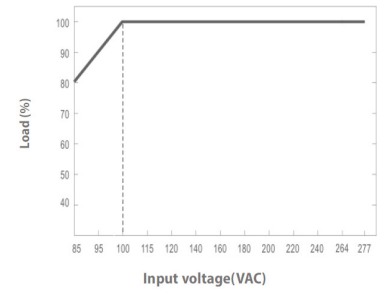

LPS-1-090-12DC

LPS Series 120W

AC-DC DIN Rail Power Supplies



Key Features

- 12, 24 & 48 VDC
- Universal Input: 90-264VAC / 120-375VDC
- High Efficiency
- Short Circuit Protection
- Internal Input Filter
- IP20 Protection Rated



Technical Specification - 120W Output

Model	LPS-1-120-12DC	LPS-1-120-24DC	LPS-1-120-48DC
Input Voltage	90-264VAC / 127-375VDC		
Output Wattage	120W		
Output Voltage / Power Dissipation	12VDC / 24W	24VDC / 20W	48VDC / 19W
Output Current	10A	5A	2.5A
Efficiency	85.5%	88%	89%
General Specification			
Approval	cURus		
Isolation Voltage	3000VAC/4242VDC		
Isolation Resistance	100MΩ @ 500VDC		
Ambient Temperature	-20 to +70°C		
Derating	(61 to 71°C) 2.5%/°C		
Storage Temperature	-40 to +85°C		
Relative Humidity	10 to 95% RH		
Cooling	Free air convection		
Dimensions	L125 x W40 x D113 (126.5 inc. DIN rail mount) mm		
Weight	600g		
Case Material	Metal		
Input Specifications			
Rated Input Voltage	115 - 230VAC (auto select)		
Input Voltage Range	90-264VAC, 127-375VDC		
Line Frequency	50/60Hz		
Power Factor @ 115VAC	0.55 Typical (0.58 Measured)		
Power Factor @ 230VAC	0.70 Typical (0.75 Measured)		
Inrush Current (115 / 230VAC)	20 / 35A		
Output Specifications			
Output Voltage Accuracy	±1%		
Minimum Load	0%		
Line Regulation	±0.5%		
Load Regulation	±1%		
Turn On Time	1000ms after AC applied to input at full resistive load		
Voltage Fall Time	150ms		
Voltage Rise Time	150ms		
Hold Up Time (115 / 230VAC)	10 / 16ms		
Temperature Coefficient	±0.03%/°C		
Ripple & Noise	120mVp-p		
Voltage Trim Range	11.4 ~ 14.5VDC	22.5 ~ 28.5VDC	45 ~ 55VDC
DC ON & LOW Indicator (Green & Red LED)	10 ~ 11.2VDC	17.6 ~ 19.4VDC	37 ~ 43VDC
Control & Protection			
Rated Overload Protection	105-130%		
Over Voltage Protection	14-17VDC	29-33VDC	50-65VDC
Output Short Circuit	Fold Forward		

LPS Series 120W AC-DC DIN Rail Power Supplies



Dimensions (mm)

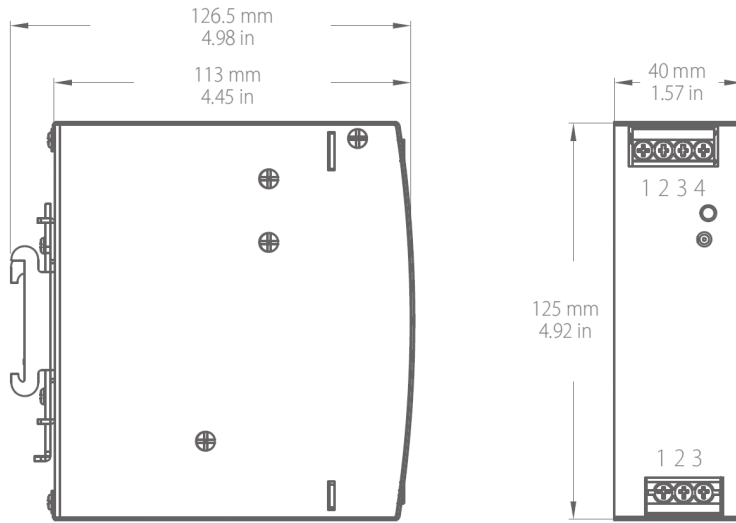

Pin Connections

Input		Output	
Pin No.	Description	Pin No.	Description
1	FG (⊕)	1, 2	DC OUTPUT V-
2	AC / N	3, 4	DC OUTPUT V+
3	AC / L		

Installation

Ventilation / Cooling

Normal convection
All sides 25mm free space
For cooling recommended

Connector Size Range

AWG24-10 (0.2 ~ 4mm²) flexible / solid cable,
- Input connector can withstand torque at maximum 9 pound-inches
- Output connector can withstand torque at maximum 5.5 pound-inches
8 m/m stripping cable end recommends
Use copper conductors only, 60 / 75°C

Construction

Easy snap-on mounting onto the DIN-Rail (TS35/7.5 or TS35/15), unit sits safely and firmly on the rail.

Derating Curve

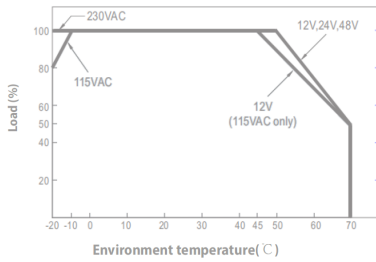

Minus Output & Input Voltage Curves

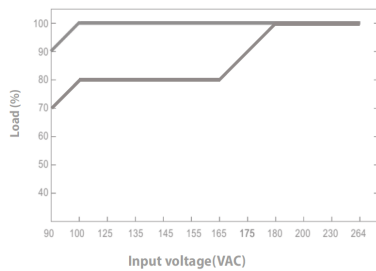

Circuit Schematic

