

Miniature DC Photoelectric Switches QB



Miniature photoelectric switches for DC operation

- Models with IR, red light and red light LASER emission
- Red light emission for transparent object detection
- Digital "Teach In" sensitivity adjustment
- Position sensor with analogue output
- Contrast detection model
- UL and CUL approved
- IP67 protection



Options and ordering codes

QB	I	6	/	0	P	-	0	E
Infrared emission	I							E M8 axial plug connection
Visible red LED emission	R							
Red LASER diode emission	L							
							0 Plastic housing	
Diffuse 300mm with sensitivity adjustment (R)		6			P PNP logic output			
Background Suppression 60mm (L)		A			N NPN logic output			
Background Suppression 100mm (R)		B			O Emitter			
Background Suppression 110mm (L)		C			A Analogue 0-10V			
Background Suppression 150mm (I)		D						
Background + Foreground Suppression (R)		3		0 Emitter or 4 wire, LOn/DOn selectable				
Diffuse Contrast (L)		L						
Fibre Optic (R)		F						
Retro-reflective for clear material detection (R)		G						
Retro-reflective 1m (L)		M						
Retro-reflective 2.5m (R)		N						
Retro-reflective 4m (R)		P						
Receiver 6m		R						
Emitter (R)		S						

Note: Some model combinations are not available, please refer to "Available models" section of this data sheet.

Specification common to all models

Operating voltage	10-30Vdc (QBR3 15-30Vdc)
Load current	100mA (not emitters)
Leakage current	≤ 10mA at Vmax (not emitters)
Switching Frequency	1kHz
Sensitivity adjustment	Push button & External connection
Red Light Emission	660 Nm, Pulsed
Infrared Emission	880 Nm, Pulsed
Laser Emission	650 Nm, Class II
Current consumption	See Model tables
Indicators	Yellow LED (Output), Green LED (signal strength)
Supply electrical protection	Polarity reversal and transient U _{imp} = 500V
Output electrical protection	Short circuit (auto-reset) and over-voltage
Protection	IP67 (EN60529)
Housing material	ABS
Storage temperature	-20° to 80°C
Operating temperature	-20° to 60°C
Weight	40g (approx)

Miniature DC Photoelectric Switches QB



continued

Specification

	Diffuse models			
	QBR6/OP-0E	QBR6/ON-0E	QBLL/OP-0E	QBLL/ON-0E
Sensing distance	300mm		150mm	
Light source	Red LED 660nm		Laser 650nm Class II	
Switching frequency (Hz)	1000		4000	
Output type	PNP	NPN	PNP	NPN
Output function	N/O,N/C selectable			
Current consumption no load (mA)	35		25	
Max. output current (mA)	100			
Max. output voltage drop (V)	2.4			
Time delay (ms)	300			
Operating indicator	LED green			
Output indicator	LED red			
Light spot at 160mm	12 x 12mm		<0.7mm	
Reference material	Kodak White 90%, 100 x 100mm			

	Background suppression models			
	QBLA/OP-0E	QBLA/ON-0E	QBLC/OP-0E	QBLC/ON-0E
Sensing distance	60mm		110m	
Light source	Laser 650nm			
Switching frequency (Hz)	1000			
Output type	PNP	NPN	PNP	NPN
Output function	N/O,N/C selectable			
Current consumption no load (mA)	< 30			
Max. output current (mA)	100			
LASER protection class	II			
Light spot	<0.3mm at 40mm		0.7mm at 85mm	
Max. Grey scale displacement (%)	7			
Operating indicator	LED green			
Output indicator	LED red			
Reference material	Kodak Grey 18%, 100 x 100mm			

	Background suppression models				
	QBID/OP-0E	QBID/ON-0E	QBRB/OP-0E	QBRB/ON-0E	QBR3/OA-0E
Sensing distance	150mm		100mm		80mm
Light source	IR 880nm		Red LED 660nm		
Switching frequency (Hz)	800		1000		200
Output type	PNP	NPN	PNP	NPN	0 - 10Vdc
Output function	N/O,N/C selectable				
Current consumption no load (mA)	25		35		25
Max. output current (mA)	100		-		
Max. output voltage drop (V)	2.4		-		
Max. Grey scale displacement (%)	10		-		
Operating indicator	LED green				
Output indicator	LED red				
Light spot	5 x 5mm at 60mm				
Reference material, 100mm x 100mm	Kodak grey 18%			Kodak White 90%	

Miniature DC Photoelectric Switches QB



continued

Specification

	Clear Material		Retro-reflective	
	QBRG/OP-0E	QBRG/ON-0E	QBLM/OP-0E	QBLM/ON-0E
Sensing distance	500mm		1m	
Light source	Red LED 660nm		LASER 650nm Class II	
Switching frequency (Hz)	1000		4000	
Output type	PNP	NPN	PNP	NPN
Output function	N/O,N/C selectable			
Current consumption no load (mA)	35		25	
Max. output current (mA)	100			
Max. output voltage drop (V)	2.4			
Operating indicator	LED green			
Output indicator	LED red			
Light spot	12 x 12mm at 160mm		1mm at 300mm	
Reference material	Reflector RL113G			

	Retro-reflective			
	QBRN/OP-0E	QBRN/ON-0E	QBRP/OP-0E	QBRP/ON-0E
Sensing distance	2.5m		3.5m	
Light source	Red LED 660nm			
Switching frequency (Hz)	1000			
Output type	PNP	NPN	PNP	NPN
Output function	N/O,N/C selectable			
Current consumption no load (mA)	35			
Max. output current (mA)	100			
Max. output voltage drop (V)	2.4			
Light spot at 2m	75 x 75mm			
Max. distance	3m		4m	
Operating indicator	LED green			
Output indicator	LED red			
Reference material	Reflector RL113G			

	Through beam			Fibre optic	
	QBRN/OP-0E	QBRN/ON-0E	QBRP/ON-0E	QBRF/OP-0E	QBRF/ON-0E
Sensing distance	-	6m		100mm (typical)	
Light source	LED 660nm	-		Red LED 660nm	
Switching frequency (Hz)	-	500		1000	
Output type	-	PNP	NPN	PNP	NPN
Output function	-	N/O,N/C selectable			
Current consumption no load (mA)	20	25		25	
Max. output current (mA)	-	100		100	
Max. output voltage drop (V)	-	2.4			
Ripple	10%				
Operating indicator	LED green				
Output indicator	-	LED red			
Max. beam angle (°)	6		-		
Contamination indicator	-	Yes			

Miniature DC Photoelectric Switches QB



continued

Dimensions (mm)

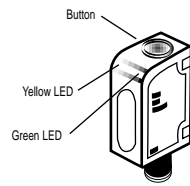

All models except QBRF

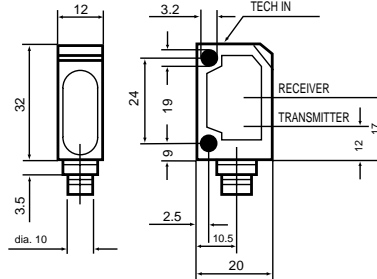

QBRF

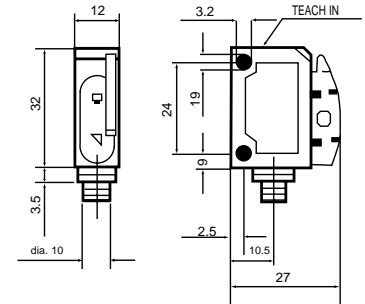

Connections

PNP Connection

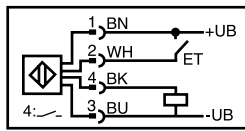

NPN Connection

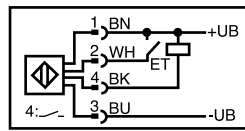

0-10v Connection

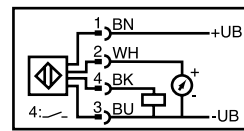

Emitter Connection

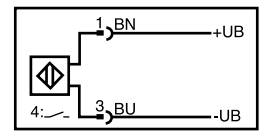

Available Models

Part Number	Function	Range	Light Source	Output	Connection
QBLL/OP-OE	Diffuse, Contrast	150mm	LASER 650nm	PNP	M8
QBLL/ON-OE	Diffuse, Contrast	150mm	LASER 650nm	NPN	M8
QBR6/OP-OE	Diffuse	300mm	Red LED 660nm	PNP	M8
QBR6/ON-OE	Diffuse	300mm	Red LED 660nm	NPN	M8
QBLA/OP-OE	Background Suppression	60mm	LASER 650nm	PNP	M8
QBLA/ON-OE	Background Suppression	60mm	LASER 650nm	NPN	M8
QBRB/OP-OE	Background Suppression	100mm	Red LED 660nm	PNP	M8
QBRB/ON-OE	Background Suppression	100mm	Red LED 660nm	NPN	M8
QBLC/OP-OE	Background Suppression	110mm	LASER 650nm	PNP	M8
QBLC/ON-OE	Background Suppression	110mm	LASER 650nm	NPN	M8
QBID/OP-OE	Background Suppression	150mm	Infrared LED 880nm	PNP	M8
QBID/ON-OE	Background Suppression	150mm	Infrared LED 880nm	NPN	M8
QBR3/OA-OE	Background / Foreground Suppression	80mm	Red LED 660nm	0-10 Vdc	M8
QBRG/OP-OE	Retro-reflective, Transparent Objects	500mm	Red LED 660nm	PNP	M8
QBRG/ON-OE	Retro-reflective, Transparent Objects	500mm	Red LED 660nm	NPN	M8
QBLLM/OP-OE	Retro-reflective	1m	LASER 650nm	PNP	M8
QBLLM/ON-OE	Retro-reflective	1m	LASER 650nm	NPN	M8
QBRN/OP-OE	Retro-reflective	2.5m	Red LED 660nm	PNP	M8
QBRN/ON-OE	Retro-reflective	2.5m	Red LED 660nm	NPN	M8
QBRP/OP-OE	Retro-reflective	4m	Red LED 660nm	PNP	M8
QBRP/ON-OE	Retro-reflective	4m	Red LED 660nm	NPN	M8
QBR3/OO-OE	Through beam emitter	-	Red LED 660nm	-	M8
QBRR/OP-OE	Through beam receiver	6m	Red LED 660nm	PNP	M8
QBRR/ON-OE	Through beam receiver	6m	Red LED 660nm	NPN	M8
QBRF/OP-OE	Fibre optic amplifier	-	Red LED 660nm	PNP	M8
QBRF/ON-OE	Fibre optic amplifier	-	Red LED 660nm	NPN	M8