



# Inductive Proximity Switches PB



## M8

Exit Type	Part Number Pre-cabled	Sn Sensing Distance mm	Type		Supply Voltage			Output				Load Current mA	Switching frequency Hz	
			Shielded	Un- Shielded	VDC		VAC	Status		Logic				
					10-30	10-36	20-250	NO	NC	NPN	PNP			
3 wire DC	PB0801/DSAN-A	1.5	●			●			●		●		150	2k
	PB0801/DSAP-A	1.5	●			●			●			●	150	2k
	PB0801/DSCN-A	1.5	●			●				●	●		150	2k
	PB0801/DSCP-A	1.5	●			●				●		●	150	2k
	PB0803/DUAN-A	3		●		●			●		●		150	2k
	PB0803/DUAP-A	3		●		●			●			●	150	2k
	PB0803/DUCN-A	3		●		●				●	●		150	2k
	PB0803/DUCP-A	3		●		●				●		●	150	2k
3 wire DC Extended sensing	PB0802/DSAN-A	2	●			●			●		●		150	2k
	PB0802-DSAP-A	2	●			●			●			●	150	2k
	PB0802/DSCN-A	2	●			●				●	●		150	2k
	PB0802/DSCP-A	2	●			●				●		●	150	2k
	PB0804/DUAN-A	4		●		●			●		●		150	2k
	PB0804/DUAP-A	4		●		●			●			●	150	2k
	PB0804/DUCN-A	4		●		●				●	●		150	2k
	PB0804/DUCP-A	4		●		●				●		●	150	2k

# Inductive Proximity Switches PB



## M12

Exit Type	Part Number Pre-cabled	Sn Sensing Distance mm	Type		Supply Voltage			Output				Load Current mA	Switching frequency Hz
			Shielded	Un- Shielded	VDC		VAC	Status		Logic			
					10-30	10-36	20-250	NO	NC	NPN	PNP		
2 wire DC	PB1202/DSA-A	2	●		●			●				50	800
	PB1202/DSC-A	2	●		●				●			50	800
	PB1205/DUA-A	5		●	●			●				50	500
	PB1205/DUC-A	5		●	●				●			50	500
2 wire DC Extended Sensing	PB1204/DSA-A	4	●		●			●				50	250
	PB1204/DSC-A	4	●		●				●			50	250
	PB1207/DUA-A	7		●	●			●				50	200
	PB1207/DUC-A	7		●	●				●			50	200
3 wire DC	PB1202/DSAN-A	2	●			●		●		●		200	800
	PB1202/DSAP-A	2	●			●		●			●	200	800
	PB1202/DSCN-A	2	●			●			●	●		200	800
	PB1202/DSCP-A	2	●			●			●		●	200	800
	PB1205/DUAN-A	5		●		●		●		●		200	800
	PB1205/DUAP-A	5		●		●		●			●	200	800
	PB1205/DUCN-A	5		●		●			●	●		200	800
	PB1205/DUCP-A	5		●		●			●		●	200	800
3 wire DC Extended Sensing	PB1204/DSAN-A	4	●			●		●		●		200	800
	PB1204/DSAP-A	4	●			●		●			●	200	800
	PB1204/DSCN-A	4	●			●			●	●		200	800
	PB1204/DSCP-A	4	●			●			●		●	200	800
	PB1207/DUAN-A	7		●		●		●		●		200	800
	PB1207/DUAP-A	7		●		●		●			●	200	800
	PB1207/DUCN-A	7		●		●			●	●		200	800
	PB1207/DUCP-A	7		●		●			●		●	200	800
2 wire AC	PB1202/ASA-A	2	●				●	●				350	25
	PB1202/ASC-A	2	●				●		●			350	25
	PB1205/AUA-A	5		●			●	●				350	25
	PB1205/AUC-A	5		●			●		●			350	25
2 wire AC Extended Sensing	PB1204/ASA-A	4	●				●	●				350	25
	PB1204/ASC-A	4	●				●		●			350	25
	PB1207/AUA-A	7		●			●	●				350	25
	PB1207/AUC-A	7		●			●		●			350	25

# Inductive Proximity Switches PB



## M18

Exit Type	Part Number Pre-cabled	Sn Sensing Distance mm	Type		Supply Voltage			Output				Load Current mA	Switching frequency Hz
			Shielded	Un- Shielded	VDC		VAC	Status		Logic			
					10-30	10-36	20-250	NO	NC	NPN	PNP		
2 wire DC	PB1805/DSA-A	5	●		●			●				50	800
	PB1805/DSC-A	5	●		●				●			50	800
	PB1810/DUA-A	10		●	●			●				50	500
	PB1810/DUC-A	10		●	●				●			50	500
2 wire DC Extended Sensing	PB1808/DSA-A	8	●		●			●				50	250
	PB1808/DSC-A	8	●		●				●			50	250
	PB1812/DUA-A	12		●	●			●				50	200
	PB1812/DUC-A	12		●	●				●			50	200
3 wire DC	PB1805/DSAN-A	5	●			●		●		●		200	800
	PB1805/DSAP-A	5	●			●		●			●	200	800
	PB1805/DSCN-A	5	●			●			●	●		200	800
	PB1805/DSCP-A	5	●			●			●		●	200	800
	PB1810/DUAN-A	10		●		●		●		●		200	800
	PB1810/DUAP-A	10		●		●		●			●	200	800
	PB1810/DUCN-A	10		●		●			●	●		200	800
	PB1810/DUCP-A	10		●		●			●		●	200	800
3 wire DC Extended Sensing	PB1808/DSAN-A	8	●			●		●		●		200	800
	PB1808/DSAP-A	8	●			●		●			●	200	800
	PB1808/DSCN-A	8	●			●			●	●		200	800
	PB1808/DSCP-A	8	●			●			●		●	200	800
	PB1812/DUAN-A	12		●		●		●		●		200	800
	PB1812/DUAP-A	12		●		●		●			●	200	800
	PB1812/DUCN-A	12		●		●			●	●		200	800
	PB1812/DUCP-A	12		●		●			●		●	200	800
2 wire AC	PB1805/ASA-A	5	●				●	●				350	25
	PB1805/ASC-A	5	●				●		●			350	25
	PB1810/AUA-A	10		●			●	●				350	25
	PB1810/AUC-A	10		●			●		●			350	25
2 wire AC Extended Sensing	PB1808/ASA-A	8	●				●	●				350	25
	PB1808/ASC-A	8	●				●		●			350	25
	PB1812/AUA-A	12		●			●	●				350	25
	PB1812/AUC-A	12		●			●		●			350	25

# Inductive Proximity Switches PB



## M30

Exit Type	Part Number Pre-cabled	Sn Sensing Distance mm	Type		Supply Voltage			Output					
			Shielded	Un- Shielded	VDC		VAC	Status		Logic		Load Current mA	Switching frequency Hz
					10-30	10-36	20-250	NO	NC	NPN	PNP		
2 wire DC	PB3010/DSA-A	10	●		●			●			50	350	
	PB3010/DSC-A	10	●		●				●		50	350	
	PB3015/DUA-A	15		●	●			●			50	300	
	PB3015/DUC-A	15		●	●				●		50	300	
2 wire DC Extended Sensing	PB3015/DSA-A	15	●		●			●			50	300	
	PB3015/DSC-A	15	●		●				●		50	300	
	PB3022/DUA-A	22		●	●			●			50	200	
	PB3022/DUC-A	22		●	●				●		50	200	
3 wire DC	PB3010/DSAN-A	10	●			●		●		●	200	500	
	PB3010/DSAP-A	10	●			●		●		●	200	500	
	PB3010/DSCN-A	10	●			●			●	●	200	500	
	PB3010/DSCP-A	10	●			●			●	●	200	500	
	PB3015/DUAN-A	15		●		●		●		●	200	500	
	PB3015/DUAP-A	15		●		●		●		●	200	500	
	PB3015/DUCN-A	15		●		●			●	●	200	500	
	PB3015/DUCP-A	15		●		●			●	●	200	500	
3 wire DC Extended Sensing	PB3015/DSAN-A	15	●			●		●		●	200	500	
	PB3015/DSAP-A	15	●			●		●		●	200	500	
	PB3015/DSCN-A	15	●			●			●	●	200	500	
	PB3015/DSCP-A	15	●			●			●	●	200	500	
	PB3022/DUAN-A	22		●		●		●		●	200	500	
	PB3022/DUAP-A	22		●		●		●		●	200	500	
	PB3022/DUCN-A	22		●		●			●	●	200	500	
	PB3022/DUCP-A	22		●		●			●	●	200	500	
2 wire AC	PB3010/ASA-A	10	●				●	●			350	25	
	PB3010/ASC-A	10	●				●		●		350	25	
	PB3015/AUA-A	15		●			●	●			350	25	
	PB3015/AUC-A	15		●			●		●		350	25	
2 wire AC Extended Sensing	PB3015/ASA-A	15	●				●	●			350	25	
	PB3015/ASC-A	15	●				●		●		350	25	
	PB3022/AUA-A	22		●			●	●			350	25	
	PB3022/AUC-A	22		●			●		●		350	25	

For device with M12 Plug connector replace the suffix 'A' with 'H'

A 2m 4 pole axial M12 cable to suit devices with M12 Plug connect is M12F0240202000

# Inductive Proximity Switches PB



## Dimensions (mm)

PB0801/\*S\*\*-A PB0802/\*S\*\*-A  
Pre-wired, Shielded Style

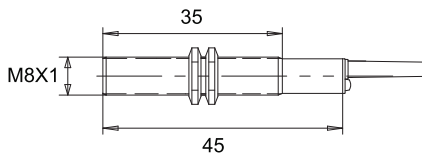

PB0803/\*U\*\*-A PB0804/\*U\*\*-A  
Pre-wired, Unshielded Style

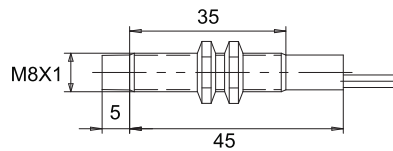

PB0801/\*S\*\*-A30 PB0802/\*S\*\*-A30  
Pre-wired, Shielded, Short Style

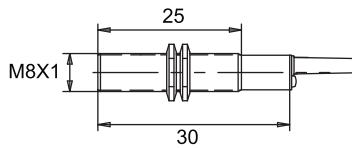

PB0803/\*U\*\*-A30 PB0804/\*U\*\*-A30  
Pre-wired, Unshielded, Short Style

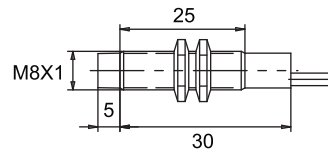

PB0801/\*S\*\*-H PB0802/\*S\*\*-H  
Quick Connector (M12), Shielded, Short

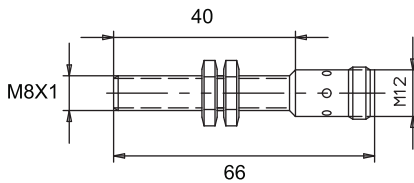

PB0803/\*U\*\*-H PB0804/\*U\*\*-H  
Quick Connector (M12), Unshielded, Short

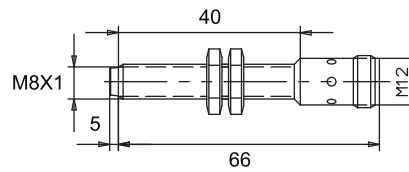

PB0801/\*S\*\*-A30 PB0802/\*S\*\*-H30  
Quick Connector (M12), Shielded, Short

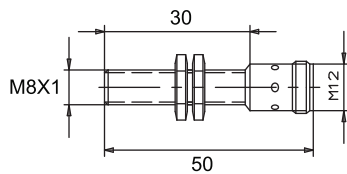

PB0803/\*U\*\*-A30 PB0804/\*U\*\*-H30  
Quick Connector (M12), Unshielded, Short

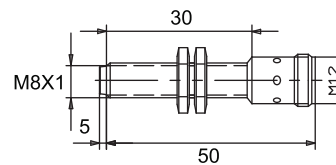

# Inductive Proximity Switches PB



## Dimensions (mm)

PB1202/\*S\*\*-A PB1205/\*S\*\*-A  
Pre-wired, Shielded Style

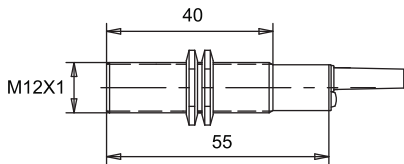

PB1204/\*U\*\*-A PB1207/\*U\*\*-A  
Pre-wired, Unshielded Style

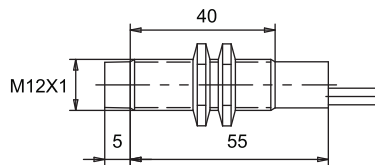

PB1202/\*S\*\*-A30 PB1205/\*S\*\*-A30  
Pre-wired, Shielded, Short Style

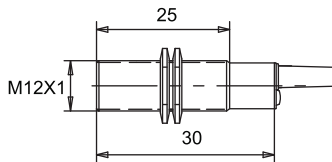

PB1204/\*U\*\*-A30 PB1207/\*U\*\*-A30  
Pre-wired, Unshielded, Short Style

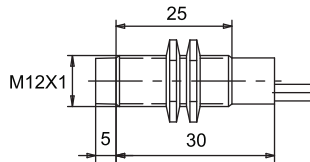

PB1202/\*S\*\*-H PB1205/\*S\*\*-H  
Quick Connector (M12), Shielded, Short

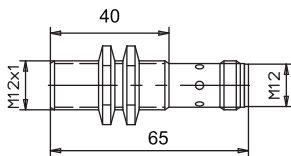

PB1204/\*U\*\*-H PB1207/\*U\*\*-H  
Quick Connector (M12), Unshielded, Short

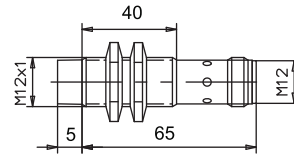

PB1202/\*S\*\*-H30 PB1205/\*S\*\*-H30  
Quick Connector (M12), Shielded, Short

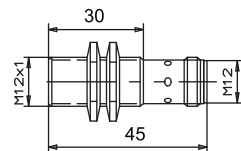

PB1204/\*U\*\*-H30 PB1207/\*U\*\*-H30  
Quick Connector (M12), Unshielded, Short

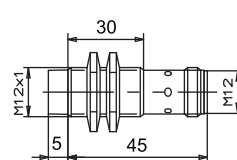

# Inductive Proximity Switches PB



## Dimensions (mm)

PB1805/\*S\*\*-A PB1808/\*S\*\*-A  
Pre-wired, Shielded Style

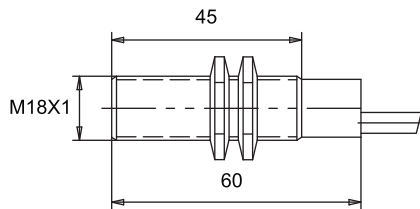

PB1810/\*U\*\*-A PB1812/\*U\*\*-A  
Pre-wired, Unshielded Style

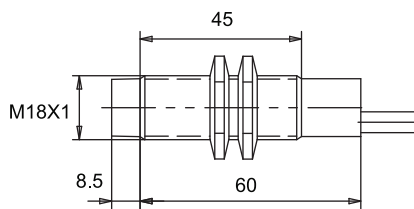

PB1805/\*S\*\*-A30 PB1808/\*S\*\*-A30  
Pre-wired, Shielded, Short Style

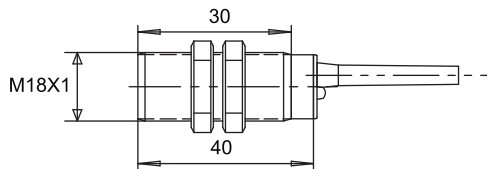

PB1810/\*U\*\*-A30 PB1812/\*U\*\*-A30  
Pre-wired, Unshielded, Short Style

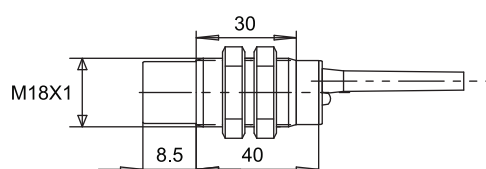

PB1805/\*S\*\*-H PB1808/\*S\*\*-H  
Quick Connector (M12), Shielded, Short

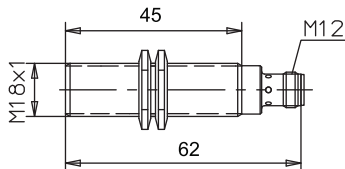

PB1810/\*U\*\*-H PB1812/\*U\*\*-H  
Quick Connector (M12), Unshielded, Short

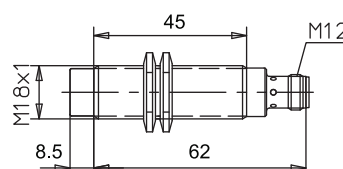

PB1805/\*S\*\*-H30 PB1808/\*S\*\*-H30  
Quick Connector (M12), Shielded, Short

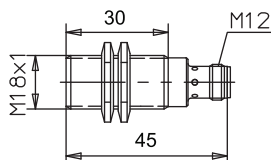

PB1810/\*U\*\*-H30 PB1812/\*U\*\*-H30  
Quick Connector (M12), Unshielded, Short

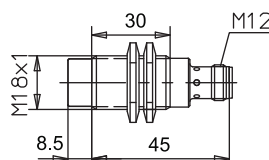



# Inductive Proximity Switches PB



## Dimensions (mm)

PB3010/\*S\*\*-A PB3015/\*S\*\*-A  
Pre-wired, Shielded Style

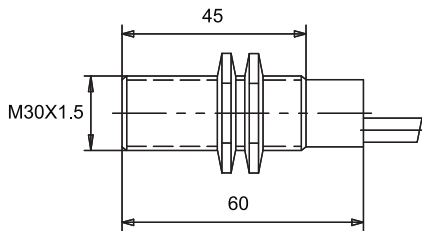

PB3015/\*U\*\*-A PB3022/\*U\*\*-A  
Pre-wired, Unshielded Style

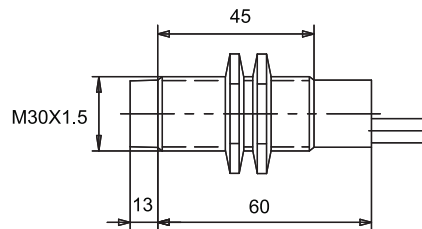

PB3010/\*S\*\*-A30 PB3015/\*S\*\*-A30  
Pre-wired, Shielded, Short Style

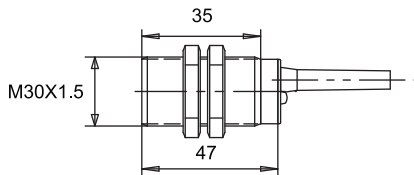

PB3015/\*U\*\*-A30 PB3022/\*U\*\*-A30  
Pre-wired, Unshielded, Short Style

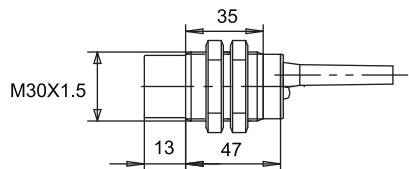

PB3010/\*S\*\*-H PB3015/\*S\*\*-H  
Quick Connector (M12), Shielded, Short

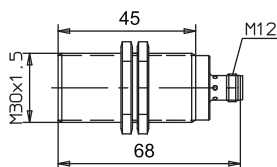

PB3015/\*U\*\*-H PB3022/\*U\*\*-H  
Quick Connector (M12), Unshielded, Short

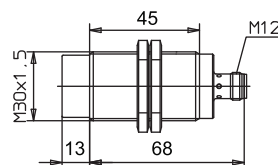

PB3010/\*S\*\*-H30 PB3015/\*S\*\*-H30  
Quick Connector (M12), Shielded, Short

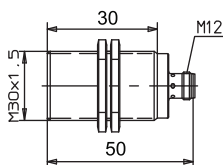

PB3015/\*U\*\*-H30 PB3022/\*U\*\*-H30  
Quick Connector (M12), Unshielded, Short

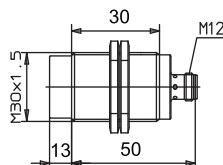

# Inductive Proximity Switches PB



## Sensing Distance (Sn)

The sensing distance of the inductive proximity sensor varies with different target materials. The sensing distance of the inductive sensors in the catalogue use a steel target. The sensing distance for other material can be calculated by multiply a correction factor shown in the table below:

Material	Attenuation coefficient
Steel	1
Stainless steel	0.85
Aluminum	0.4
Brass	0.4
Copper	0.3

The sensing distance will also vary with different size and shape of the target. A square target block will result in a longer sensing distance than a round one. A bigger target will have a longer sensing distance.

Note: Operating frequency of the inductive proximity switch is measured at  $1/2 S_n$ .

Repeat Accuracy (R) Ratio of the difference value between any of the two measurements and distance of checking ( $S_n$ ).  
 Return Difference (H) Distance between operating point when target metal moves close to proximity switch and rest point when target metal moves away from proximity.

## Wiring Diagram

	Leadwire N.O.	Leadwire N.C.	Quick Connect N.O.	Quick Connect N.C.
NPN three-wire DC				
PNP three-wire DC				
two-wire AC				

Note: Load with two-wire AC can be connected to either of the brown or blue leadwire

## Series and Parallel

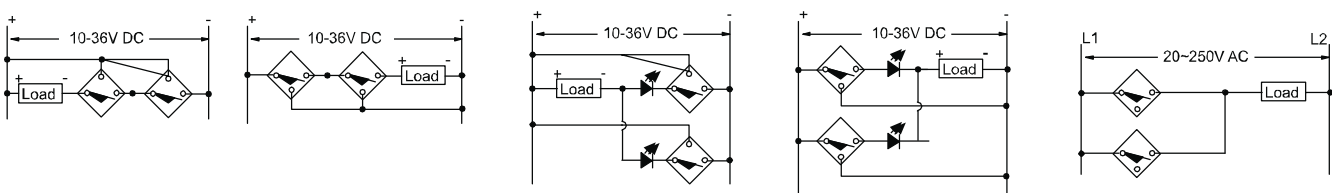

Note:

- For series connection, if sensor do not operate stably, provide each with 500 k to 10 M resistor in parallel. This will stabilise the voltage and allow the sensor to operate stably.
- Use parallel connect only when 2 or more sensors are not activated simultaneously. The leakage current, however, will be n times the value for each sensor and reset failures will frequently occur.

## Mounting Requirements

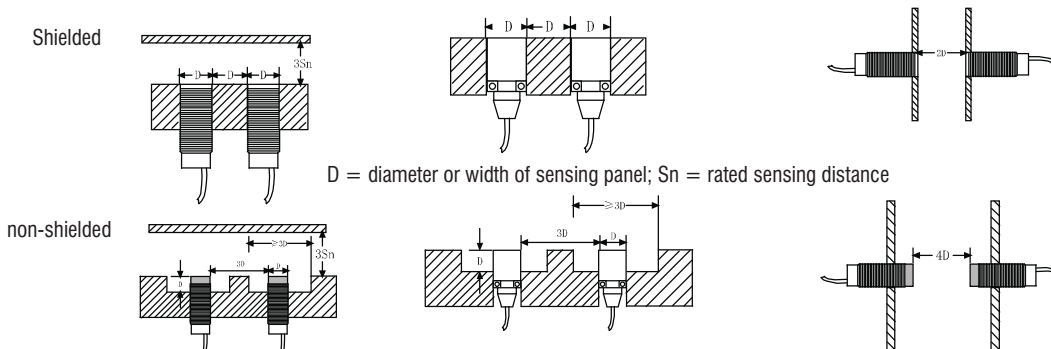

D = diameter or width of sensing panel; Sn = rated sensing distance