

Relay sockets for SRRHN, SRP, SRRT, SRRNS, SRPT, ERP, ERR relays





- Suitable for SRRHN, SRP, SRRT, SRRNS, SRPT, ERP, ERR relays
- Dielectric strength 5000 VAC min.
- Insulation strength 1000MΩ
- Two mounting types are available: PCB or DIN Rail and Screw mounting
- Components available: retainers, markers, jumpers and plug-in modules

Characteristics



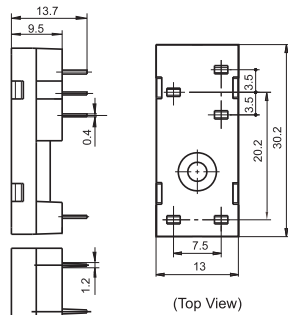
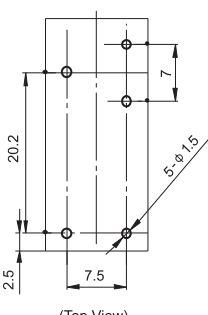

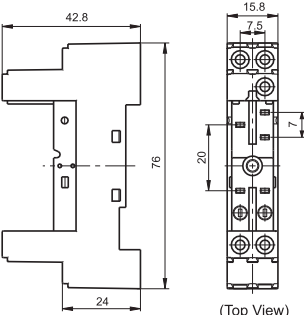
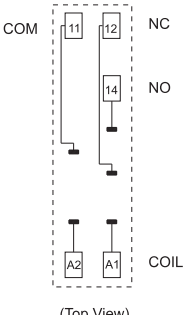

Product	Nominal Voltage	Nominal Current	Ambient Temperature	Dielectric Strength min.	Screw Torque, Nm	Wire Strip Length
SRS1-0	250VAC	10A	-40 to 70°C	5000 VAC	-	-
SRN3-T	250VAC	10A	-40 to 70°C	5000 VAC	0.6	7 mm
SRN3-S	250VAC	10A	-40 to 70°C	5000 VAC	0.6	7 mm
SRS2-0	250VAC	10A	-40 to 70°C	5000 VAC	-	-
SRN5-T	250VAC	10A	-40 to 70°C	5000 VAC	0.6	7 mm
SRN5-S	250VAC	10A	-40 to 70°C	5000 VAC	0.6	7 mm
SRN5-ST	250VAC	10A	-40 to 70°C	5000 VAC	0.6	7 mm

Outline dimensions, Wiring diagram and PC Board layout(mm)

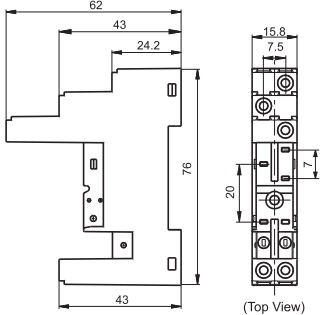
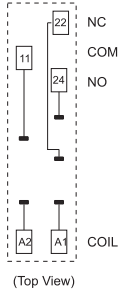
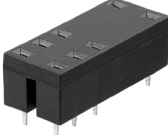
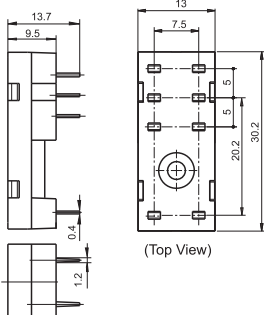
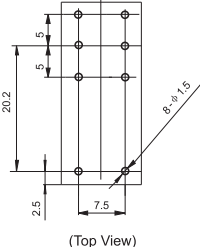
Socket	Outline dimensions	Wiring Diagram / PCB Layout	Components Available
<p>SRS1-0</p>  <p>PCB terminal PCB mounting Applicable for SRRHN 1 pole, SRRNS-1A, ERR-1C</p>	 <p>(Top View)</p>	 <p>(Top View)</p>	<p>Metallic retainer E-CLIP-1 applicable for SRRHN, SRRNS relays</p> <p>E-CLIP-3 applicable for ERR 1 pole relays</p>
<p>SRN3-T</p>  <p>Screw terminal DIN rail and Screw mounting Applicable for SRRHN 1 pole, SRRNS-1A, ERR-1C Plastic retainer and marker included</p>	 <p>(Top View)</p>	 <p>(Top View)</p>	<p>Plug-in modules PDM1 to PRM1</p>

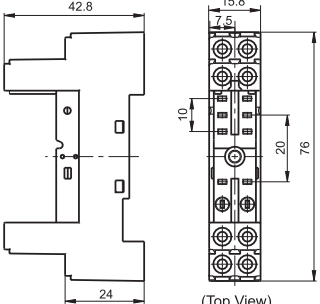
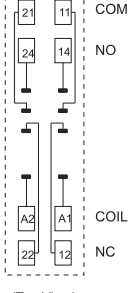
Relay sockets for SRRHN, SRP, SRRT, SRRNS, SRPT, ERP, ERR relays

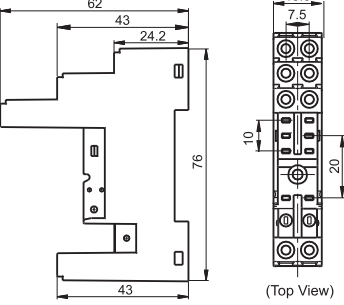
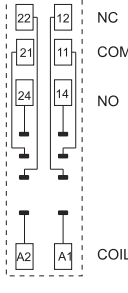

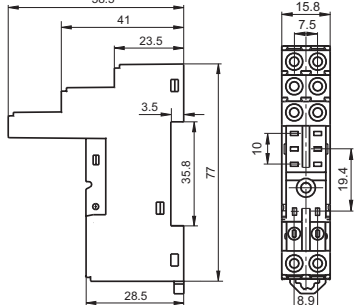
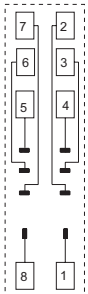
Socket	Outline dimensions	Wiring Diagram / PCB Layout	Components Available
<p>SRN3-S</p>  <p>Screw terminal DIN rail and Screw mounting Applicable for SRRHN 1 pole, SRRNS-1A, ERR-1C Plastic retainer and marker included</p>	 <p>(Top View)</p>	 <p>(Top View)</p>	<p>Plug-in modules PDM1 to PRM1</p>
<p>SRS2-0</p>  <p>PCB terminal PCB mounting Applicable for SRRHN, SRP, SRRT, SRRNS, SRPT, ERP, ERR 2 poles Metallic retainer included</p>	 <p>(Top View)</p>	 <p>(Top View)</p>	<p>Metallic retainer E-CLIP-1 applicable for SRRHN, SRRNS relays</p> <p>E-CLIP-3 applicable for ERR 1 pole relays</p>
<p>SRN5-T</p>  <p>PCB terminal DIN rail and Screw mounting Applicable for SRRHN, SRP, SRRT, SRRNS, SRPT, ERP, ERR 2 poles Plastic retainer and marker included</p>	 <p>(Top View)</p>	 <p>(Top View)</p>	<p>Plug-in modules PDM1 to PRM1</p>
<p>SRN5-S</p>  <p>Screw terminal DIN rail and Screw mounting Applicable for SRRHN, SRP, SRRT, SRRNS, SRPT, ERP, ERR 2 poles Plastic retainer and marker included</p>	 <p>(Top View)</p>	 <p>(Top View)</p>	<p>Plug-in modules PDM1 to PRM1</p>
<p>SRN5-ST</p>  <p>Screw terminal DIN rail and Screw mounting Applicable for SRRP relays Plastic retainer and marker included</p>	 <p>(Top View)</p>	 <p>(Top View)</p>	<p>Plug-in modules PDM1 to PRM1</p>

Relay sockets for SRRHN, SRP, SRRT, SRRNS, SRPT, ERP, ERR relays



Dimensions of related component

Unit: mm

Retainers

E-Clip-1

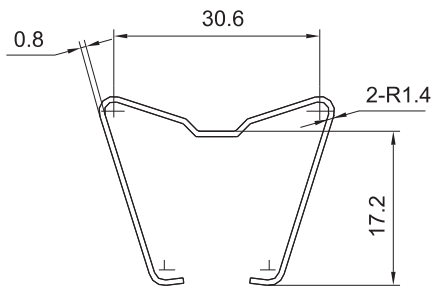

E-Clip-3

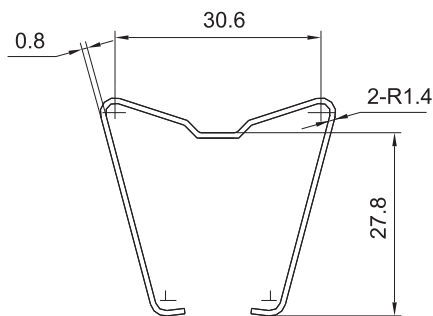

Plug-in Modules

PDM1 to PRM1

