



SMART MOTOR DEVICES

<http://smd.ee>

**PROGRAMMABLE STEP MOTOR
CONTROLLER SMSD-4.2LAN and SMSD-8.0LAN**

Manual
Ver. 07

2019



1. Product designation

Programmable step motor controller SMSD-4.2LAN is designed to operate with hybrid two or four-phase stepper motor with maximum current per phase up to 4.2Amp (SMSD-4.2LAN) or 8.0Amp (SMSD-8.0LAN). Three control modes are provided: programmable, analog control and position pulse control. The controller provides programming and control via USB or Ethernet.

2. Functions and possibilities

- Remote control through Ethernet;
- Standalone motor control according to one of 4 independent executing program sequences, stored in the controller's memory;
- Real time stepper motor control by commands forwarded from a computer via USB or through a local network Ethernet;
- Recording and reading of executing program sequences through a local network Ethernet or USB interface;
- The controller keeps in memory up to 4 independent executing program sequences. Each one can be started in a standalone control mode or called via communication interface (Ethernet or USB); every program can be called and used as a subprogram of any other program. Every program contains up to 255 control commands;
- Program control of an internal relay is provided;
- Motor control parameters (such as current per phase, holding current, microstepping mode, control mode) are adjusted using menu of the controller or via communication interface (Ethernet or USB);
- Pulse position control with standard signals 0/5VDC (up to 24VDC on condition that additional current limiting resistances are used) «STEP», «DIR» and «ENABLE» is provided;
- Analog speed control is provided: using internal or external potentiometers or analog voltage signal 0..5VDC;
- Analog position control is provided: using internal or external potentiometers or analog voltage signal 0..5VDC;
- Motor stop is provided as received signal from an emergency sensor;
- Change of motor motion direction is provided as received signal from a revers sensor;
- Homing position function is provided;
- Storage of a label (current) position and motion to the label position is provided;
- Synchronized operation of several controllers and other devices is provided by inputs and outputs;
- Automatic source voltage control – if the power supply falls outside the allowance range (less than 20VDC or more than 51VDC) when the controller is switched on or within 2 seconds during operation, the controller outputs the alarm;
- A motor acceleration and deceleration is adjusted from a controller menu or via communication interface;
- The controller is equipped with an internal brake resistor. External brake resistor can be connected as well if needed;
- Alarm sound and indication of a code of the alarm are provided;
- 2-sign 7-segment display is provided for indication of alarms, control modes and the controller adjustment;
- 32-bit password secures access through the local network, 1 second interval of authorization provides strong access protection (exhaustive search requires 136 years).

3. Technical characteristics

Table 1.

	SMSD-4.2LAN	SMSD-8.0LAN
Common characteristics:		
Maximum current per phase, Amp	4.2	8.0
Minimum current per phase, Amp	0.1	
Microstepping	1/1, 1/2, 1/4, 1/8, 1/16, 1/32, 1/64, 1/128	
Power supply, VDC	24 - 48	
Dimensions, mm (no more)	120x110x35	120x110x45
Control inputs:		
High voltage level, VDC	(24VDC on condition of using additional current limiting resistors)	
Low voltage level, VDC	0-1	
Input resistance, kOhm, no less	1	
Output relay parameters:		
Type	solidstate relay	
Max. voltage, V	± 350	
Max. current, mA	± 120	
Resistance at close contact, Ohm, no more	30	
Outputs «ALARM» and «FAULT» parameters		
Type	Opto coupler output	
Max. voltage, VDC	20	
Max. current, mA	100	
Resistance at close contact, Ohm, no more	100	
Internal output +5VDC		
Voltage, VDC	4,5 – 5,5	
Max. Load current, mA	200	
Output resistance, Ohm	50	

Environmental Conditions:

Ambient Temperature: (-25...+40)°C

Humidity: 90%RH or less upon condition +25°C

Condensation and freezing: none.

Pressure: 650...800 mm of mercury.

4. Construction

SMSD-4.2LAN and SMSD-8.0LAN were designed to fit all the needed equipment on to a portable and efficient heat-sink mounted into a plastic case with DIN rail mount. SMSD-8.0LAN has a fan, mounted of the heat-sink, which provides active cooling.

All the inputs, outputs and control elements are marked on the top side of the controller as shown on Pic. 1.

At the controller frame there are:

- terminal screws for connection of stepper motor leads and power supply;
- buttons «START/STOP» and «RESET», the same meaning signals terminal screws «START/STOP», «RESET»;
- internal adjustable resistor and terminals for connection of external potentiometer – for speed or position analog control;
- buttons for controller adjustment;
- 2-sign 7-segment display for indication of alarms, control modes and the controller adjustment;
- microswitches SW1 – SW2 for control mode adjustment;
- output +5VDC;
- USB connector to link with a computer;
- LAN connector to link to a local network;
- Signal inputs and outputs for operation control (see the table 2).

Please, refer to picture 1 and table 2 for information on controls location and designation.

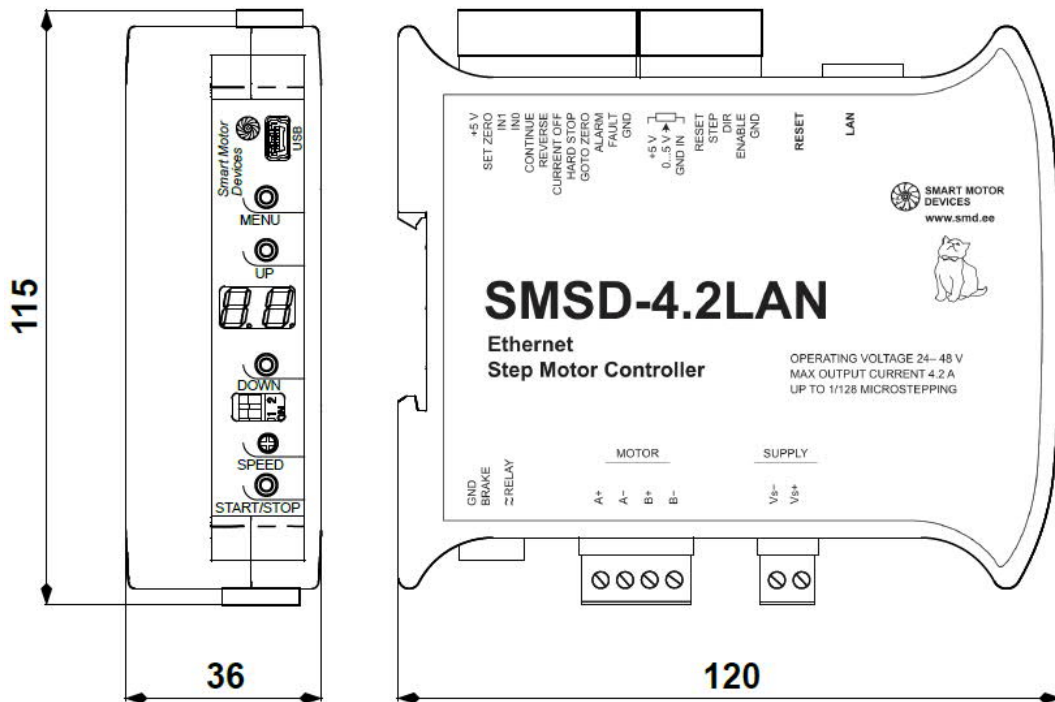

Pic. 1a. Dimensions and input/output and controls location - SMSD-4.2LAN

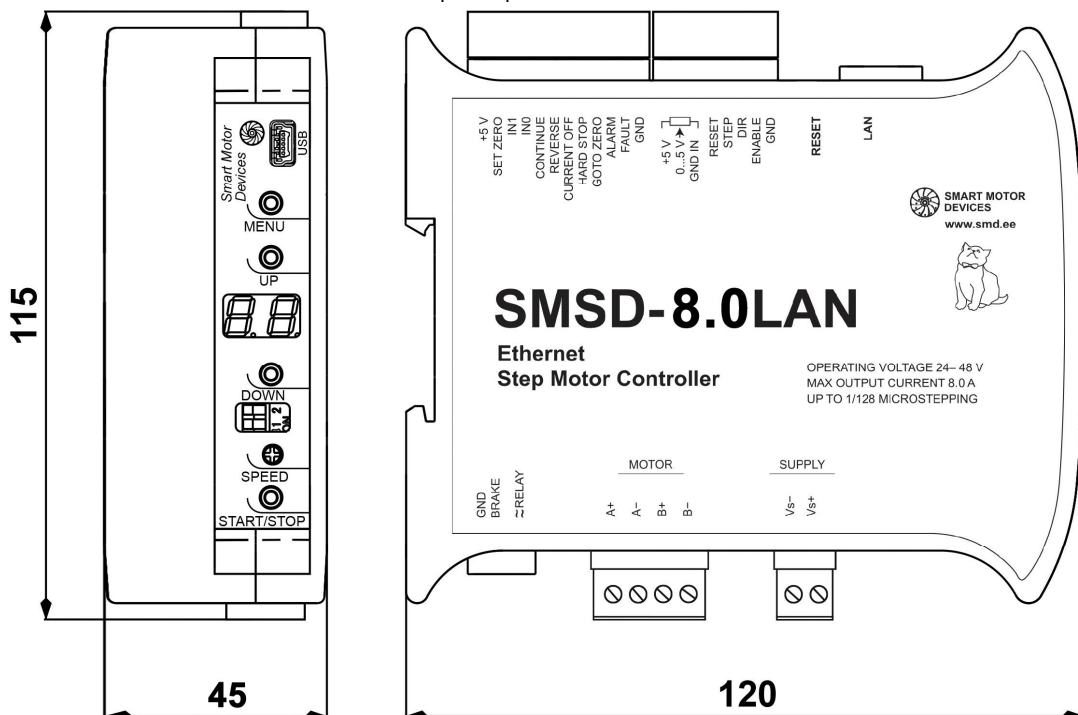

Pic. 1b. Dimensions and input/output and controls location - SMSD-8.0LAN



Table 2

Mark	Designation		Wiring	
GND	Controller power supply terminal			
+VDD	Negative side of a power supply unit (24..48VDC)			
A+	Positive side of a power supply unit (24..48VDC)			
A-	Phase A+		Part 6 «Stepper motor connection» - table 3	
B+	Phase A-			
B-	Phase B+			
B-	Phase B-			
GND	Brake resistance connection screw terminals			
RES BRAKE	Screw terminals for connection of the output relay of the controller – connect to an external controlled device			
~RELAY				
~RELAY				
+5V	Output +5VDC		Pic. 2	
SET ZERO	Input – set of a home (zero) position		Pic. 2, Pic. 3	
IN1	Input – programmable input 1			
IN0	Input – programmable input 0			
CONTINUE	Input – resume of an interrupted operation			
REVERS	Input – change motion direction			
CURRENT OFF	Input – motor phases deenergizing			
HARD STOP	Input – sudden motor stop			
GOTO ZERO	Input – move to home (zero) position			
ALARM	Output – alarm indication			
FAULT	Output – normal operation			
GND	GND – common information input		Pic. 2	
+5V IN	Signal lines connector	Connection of an external potentiometer – speed and position analog control	+5VDC output for external potentiometer connection	
SPEED IN				Input for middle line of potentiometer
GND IN				GND – common line for potentiometer
RESET	Pulse position control	Reset	Input – reset of the controller	Pic. 2, pic. 3
STEP		Input – STEP (pulse signal)	Pic. 5	
DIR	Pulse position control	Input – DIR (level signal)	Input – ENABLE (level signal)	Pic. 2, pic. 3
ENABLE		Input – ENABLE (level signal)		
GND		GND – common input (for STEP signal)		
RESET	Button	reset of the controller		
LAN	Communication connectors		Ethernet – local network connection	
USB	Communication connectors		USB connection to a computer	
MENU	Menu control buttons		Enter/exit/navigation through the menu of the controller	
UP	Menu control buttons		Increase menu parameter	
DOWN	Menu control buttons		Decrease menu parameter	
SW1, SW2	Microswitches		Control mode setting	
SPEED	Potentiometer		Internal adjustable resistor for speed and position analog control	
START/STOP	Button		Operation start/stop	

5. Connection

Please follow this manual carefully for connection and assembly.

Please, connect wires only when power is off. Do not attempt to change wiring while the power is ON.

Please, provide a reliable contact in connection terminals. During wiring, please, observe the polarity and wire management. Connection examples are shown on pictures 2-7. Possible connection schemes for motors are given below in table 3.

Connection examples for control inputs and outputs of the controller:

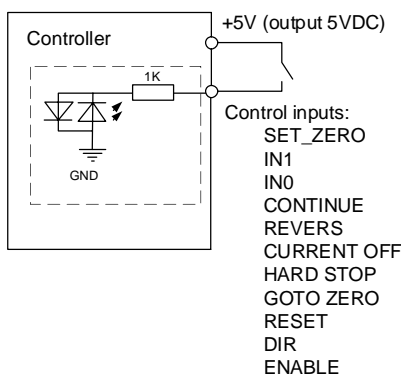

Pic. 2. Connection of input lines using internal power supply +5VDC

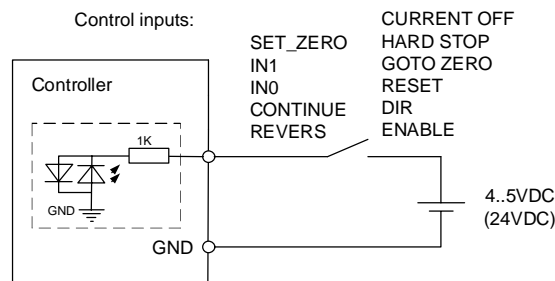

Pic. 3. Connection of input lines using external power supply (4-5VDC).

Please, connect additional current limiting resistance if use high level signal +24VDC instead of 5VDC: 3KOhm for STEP input, 1KOhm for all the rest inputs.

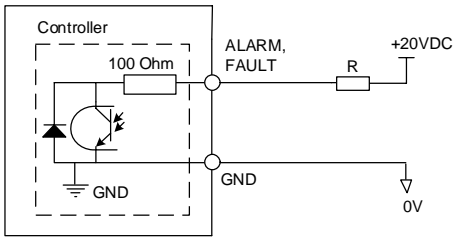

Pic. 4. Connection of output lines ALARM and FAULT. Outputs type - optoisolator output, max. voltage: 20VDC, max. current – 100mA

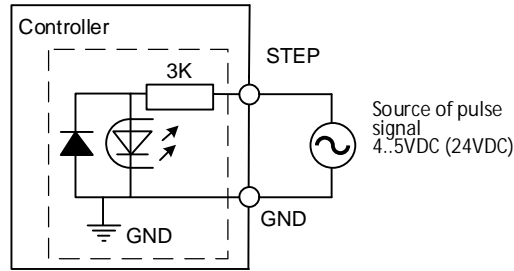

Pic. 5. Connection of STEP signal

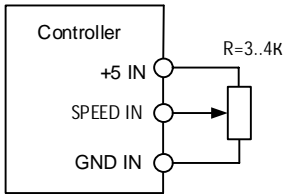

Pic. 6. Connection of an external potentiometer for speed or position analog control

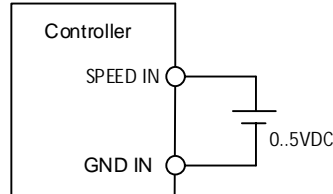

Pic. 7. Connection example for speed or position control using an external source of analog signal 0–5VDC.

Connection of an external brake (regenerative) resistance

Brake (regenerative) resistor is meant to be used to absorb and dissipate energy, which appears due to deceleration or forced rotation of the motor. The controller is equipped with an internal regenerative resistor for 5W. The power of the resistor is suitable for normal operation of a stepper motor SM8680.

In case of forced motor rotation at a speed below 120rpm (10 seconds average value at the desired interval from 0 to infinite), using of an external regenerative resistor is not necessary.

In case of forced motor rotation at a speed 120...240 rpm (10 seconds average value at the desired interval from 0 to infinite), it is necessary to connect an external brake regenerative resistor $R=5 \text{ Ohm}$ $P=100W$. The load resistor should be connected to the screw terminals «GND» and «RES BRAKE».

Long duration forced motor rotation at average velocity more than 240 rpm (10 seconds average value at the desired interval from 0 to infinite) is forbidden.

Connection of a stepper motor

The controller provides operation with 2 or 4-phase stepper motors, 4, 6 or 8 wires. Winding connection examples are in the table 3. Connect stepper motor wires to A+, A-, B+ and B- terminals of the controller according to the table 3.

Table 3.

<p>Scheme 1</p>	<p>Scheme 2</p>	<p>Scheme 3</p>	<p>Scheme 4</p>
<p>8 wires stepmotor connection (4 phases): Scheme 1 – serial connection; Scheme 2 – parallel connection.</p> <p>6 wires stepmotor connection (2 phases with midpoint taps): Scheme 3;</p> <p>4 wires stepmotor connection (2 phases without midpoint taps): Scheme 4.</p>			

Connection and assembling

Assembling order is as below:

1. Connect the controller to a stepper motor, sensors and power supply according to the given schemes and recommendations;
2. If necessary, connect an external regenerative resistor;
3. If necessary, connect the controller to a computer through the LAN or USB.



6. Controller menu

For the purposes of the controller adjusting the special controller menu is used (buttons MENU, UP and DOWN and 2-sign 7-segment display). Some parameters could also be set through the communication interface (using Ethernet or USB connection).

6.1 Usage of the controller menu

To enter menu press and hold the button MENU till a sound signal (values at the display should start to blink). To change the menu item shortly press the button MENU again (menu switching is cyclic). To exit the menu press and hold the button MENU till a sound signal (values at the display should stop blinking). To change the parameter of a menu item, use the buttons UP (to increase the value) and DOWN (to decrease the value).

Factory reset – simultaneous pushing and holding of UP and DOWN buttons longer than 8 sec till a sound signal.

6.2 Menu items are the next:

- P0 – select a motor control mode: Cu – current mode, Un – voltage mode
- P1 – select a motor type for the voltage motor control mode: 1..43 (P0=Un)
- P2 – select microstepping mode: 1..16 – for current motor control mode, 1..128 for voltage motor control mode
- P3 – select operating current for current motor control mode: 0,1 – 4,2A or 0,1 – 8,0A (P0 = Cu)
- P4 – select holding current – as a percentage of an operating current: 25%, 50%, 75%, 99%
- P5 – select the number of an executing program P0..P3 which should be executed as the button START/STOP is pushed
- P6 – select the analog control mode type: A0/A1 (analog speed control A0 or analog position control A1)
- P7 – select acceleration rate: 0..15 (calculated as $3 * 2^N$ steps/sec², N – set value)
- P8 – select deceleration rate: 0..15 (calculated as $3 * 2^N$ steps/sec², N – set value)
- P9 – select a filter time for inputs IN0, IN1, REVERS, SET_ZERO (to prevent malfunction due to a contact bounce) – 2^n ms (n – the menu parameter value)
- PA – turn on/turn off sound signals: ON/OFF
- PB – select display brightness: L0..L7
- PC – ENABLE input setting for control modes A0 and A1: 0 – phases deenergized, 1 – phases energized.
- PD - a maximum program number, which could be switched in bF control mode.



6.3 Stepper motors list and numbers for the voltage motor control mode (menu item P1, P0 = Un):

Value		Max. current per phase, Amp	Resistance per phase, Ohm	Inductance per phase, mH	Step angle	Motor model
SMSD-4.2LAN	SMSD-8.0LAN					
0	0	-	-	-	-	No motor
1	1	1.33	2.1	2.5	1.8	
2	2	1.33	2.1	4.2	0.9	
3	3	1.2	3.3	3.4	0.9	
4	4	1.68	1.65	3.2	1.8	
5	5	1.68	1.64	3.2	0.9	
6	6	1.2	3.3	2.8	0.8	
7	7	1.68	1.65	2.8	1.8	SM4247
8	8	1.68	1.65	4.1	0.9	
9	9	1.2	6	7	1.8	
10	10	1.2	12.1	36.7	0.9	
11	11	1.56	1.8	3.6	1.8	
12	12	1.0	16.7	46.5	1.8	
13	13	1.5	3.6	6	1.8	
14	14	1.0	5.7	5.4	1.8	
15	15	1.0	5.7	8	0.9	
16	16	2.8	0.7	1.4	1.8	
17	17	2.8	0.7	2.2	0.9	
18	18	1.0	6.6	8.6	1.8	
19	19	2.8	0.83	2.2	1.8	
20	20	2.8	0.9	3.7	0.9	
21	21	1.0	7.4	10	1.8	
22	22	2.0	1.8	2.5	1.8	
23	23	2.8	0.9	2.5	1.8	
24	24	1.0	8.6	14	1.8	
25	25	2.8	1.13	3.6	1.8	SM5776
26	26	2.8	1.13	5.6	0.9	
27	27	2.0	1.2	4.6	1.8	
28	28	2.0	4.8	18.4	1.8	
29	29	2.0	1.5	6.8	1.8	
30	30	2.0	6	7.2	1.8	
31	31	2.8	0.7	3.9	1.8	
32	32	2.8	2.8	15.6	1.8	
33	33	4.2	0,375	3.4	1.8	SM8680 Parallel connection
34	34	4.2	1.5	13.6	1.8	SM8680 Serial connection
35	35	4.2	0.45	6	1.8	-
36	36	4.2	1.8	24	1.8	-
37	37	4.2	0,625	8	1.8	-
38	38	4.2	2.5	32	1.8	-
	39*	6.0	0.6	6.5	1.8	-
	40*	6.2	0.75	9	1.8	-
	41*	5.5	0.9	12	1.8	-
	42*	6.5	0.8	15	1.8	-
	43*	8	0.67	12	1.8	SM110201
39	44	0.3	32	40	1.8	-
40	45	0.67	8.5	7.5	1.8	-
41	46	1.68	2.3	3.4	1.8	-
42	47	3.0	1.0	3.4	1.8	-
43	48	3.0	1.45	6.5	1.8	-
44	49	3.0	1.2	6.4	1.8	-
45	50	4.5	0.36	3.0	1.8	-
-	51	6.0	0.6	5.7	1.8	-
-	52	6.2	0.7	8.5	1.8	-
-	53	8.0	0.8	16	1.8	-
-	54	6.0	0.8	8.7	1.8	-

7. Operation order

1. Make sure the power supply is turned off.
2. Make assembly and connection according to section 5.
3. Set controller operation parameters: motor control mode (current or voltage), operation current (for current control mode) or motor model (for voltage control mode), holding current, microstepping mode and other necessary parameters (please, refer to the section 6).

Current control mode – during the motor control the target parameter is a maximum operation current given to a motor phase. If use this control mode, it is possible to connect any motor to the controller under the condition of a correct current setting (use the menu of the



controller) in an available range 0.1 – 4.2A (0.1 – 8.0A). The current motor control mode performs better torque and high rotation speed, but it is limited with a maximum microstepping division 1/16;

Voltage control mode – performs smooth motion and provides microstepping division up to 1/128. However, rotation speed and torque are less in comparison with the current control mode. This control mode is only applicable to the exact list of motor models. The models list resides in the controller memory (please, refer to the section 6.3).

In case of control through Ethernet or via USB interface, the parameters can be adjusted by command using the controller communication interface. Otherwise use the controller menu to adjust the parameters.

The parameters adjusting using the controller menu

- Chose the motor control mode – voltage or current. Enter the menu P0, use buttons UP and DOWN to select chosen control mode: Cu – current, Un – voltage.
 - In case of current control mode (P0=Cu), enter the menu P3 and select the maximum operation current of the connected motor (please, refer to the motor documentation).
 - In case of voltage control mode (P0=Un), enter the menu P1 and select the motor model. List of motor models can be found in the section 6.3.
 - Enter the menu P2 and select required microstepping mode (1..1/16 if current control mode chosen or 1..1/128 if voltage control mode chosen).
 - Enter the menu P4 and select required holding current – as a percentage of the operation current: 25%, 50%, 75%, 99%.
 - If it is intended to use a standalone operation mode according to an executing program from the controller memory, enter the menu P5 and select a number of an executing program (it will be executed as the button START/STOP will be pushed).
 - If it is intended to use an analog control mode, enter the menu P6 and select A0 for analog speed control or A1 for analog position control.
 - Set suitable values of a motor acceleration and deceleration – enter menu P7 and P8 accordingly.
 - Enter the menu P9 and set the debouncing filter value (signal insensitive time) for debouncing inputs.
4. Select a required operation mode using microswitches SW1, SW2 according to the table 4.

Table 4.

Operation mode	Mark on the display	Microswitch		Operation
		SW1	SW2	
Local network Ethernet or USB	La	ON	ON	The operation control is realized by commands according the communication protocol of the controller. Ethernet or USB connection is used.
Program executing	bF	OFF	ON	The controller executes one of the saved to it's memory program.
Analog control	A0, A1	ON	OFF	A0 – analog speed control; A1 – analog position control; For analog control internal or external potentiometers is used, or the signal is given by an external analog source of 0..5VDC.
Driver	SD	OFF	OFF	The standard pulse position control using control signals «STEP», «DIR» and «ENABLE».

- **If used driver operation mode - standard pulse position control SD**, give a sequence of signals «STEP» (pulse), «DIR» (level) and «ENABLE».

High level of the signals – 4..5VDC (24VDC*), low level - 0..1VDC.

One step (or microstep) executes as front edge of the voltage pulse on the «STEP» input. Direction switches by changing voltage level on the «DIR» input. The motion is enabled if the signal to «ENABLE» input is given. The signals oscillogram is shown on pic.8.

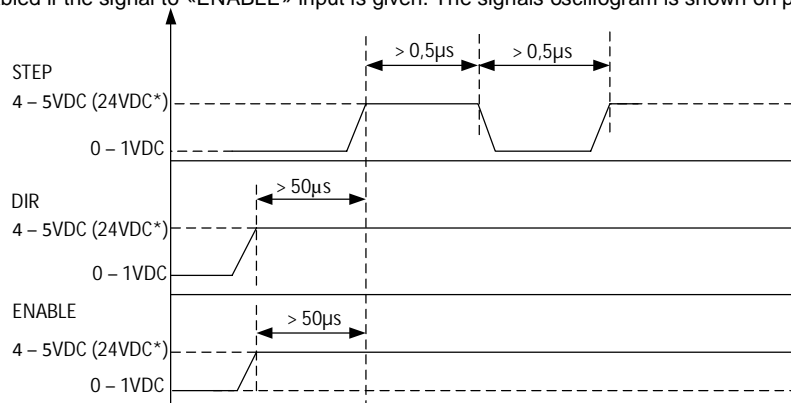

Pic.8 – «STEP», «DIR» and «ENABLE» signals order and duration

*Please, connect additional current limiting resistance if use high level signal +24VDC instead of 5VDC: 3KOhm for STEP input, 1KOhm for all the rest inputs.

- **If used analog operation mode A0, A1** – control the motor velocity (if chosen menu P6=A0) or turning angle (if chosen menu P6=A1) using



a potentiometer or source of analog signal 0 – 5VDC. The motor motion can be started and stopped by pressing the START/STOP button, or by signal at the ENABLE input. The motor speed (or turning angle) is regulated by the internal potentiometer "SPEED", by external potentiometer or source of an analog signal 0-5VDC – which should be connected to the input "SPEED IN". When use one regulation input, another one should be turned off (switch to the zero position).

- In an analog speed control mode A0 - the maximum rotation speed is 2000 rpm for a stepper motor with step angle 1.8° and operation in a full step mode. In case of operation in a microstepping mode, the maximum rotation speed is lower proportional to a microstepping ratio.
- In an analog position control mode A1 - microstepping below 1/16 is not applicable. In case of microstepping ratio 1/16 for a stepper motor with step angle 1.8° - the maximum rotation angle is 270°; in case of microstepping ratio 1/32 – 135°; 1/64 – 67,5°; 1/128 – 33,7°. The maximum momentary target speed is 600 steps/sec.
- **Executing program operation mode bF** – The program execution can be started and stopped by pressing the START/STOP button, or by signal at the ENABLE input. It is possible to choose one of 4 stored in the controller memory programs. The needed program should be selected in the controller menu P5 - the program number is the menu parameter (please, refer to the section 6).
- **When use local network Ethernet (or USB) operation mode LA**, operation and motion control is performed by commands – through the local network Ethernet or via USB interface. All connection parameters, authorization method and a full command list are given in the communication protocol manual.

Designation of the control inputs, which are used in the mentioned operation modes, are given in the section 4 table 2. Signal inputs are activated by the high voltage level. The motor rotation direction depends on a signal level on the input DIR, rotation direction can be changed to the opposite by impulse signal at the REVERS input. An emergency stop is implemented when high voltage level appears at the CURRENT OFF input.

8. Ethernet and USB connection

The controller provides 2 communication interfaces –connection via local network Ethernet or USB. In case of connection of the controller to a computer there is a possibility to adjust controller parameters and control of a stepper motor by commands. Please, refer to a full description of the data communications protocol in a relevant document. The data communications protocol is open.

Besides the open data communications protocol, we offer a specific software for the controller (OS Windows only). This software SMC-Program Ver.5 provides both USB and Ethernet connections, it is suitable for the controller adjusting and a motor control.

Please, use a LAN cable for connection to a local network Ethernet (it is a part of delivery). Default LAN connection parameters are next:

MAC address : 0x00 0xf8 0xdc 0x3f 0x00 0x00
IP address: 192.168.1.2
Port: 5000
IP sub-network mask: 255.255.0.0
Gateway: 192.168.1.1

These parameters can be changed afterwards by commands sent through a USB or Ethernet connection.

Please, use a USB cable for connection to a USB (it is a part of delivery). Special driver (CP210x_VCP) must be installed before the connection. A virtual COM port appears on a computer after connection of the controller to a computer USB port. The following data communication is performed as per RS-232 interface, parameters are the next:

Baud rate - 115200
Data bits - 8
Parity – none
Stop bits - 1

9. SMC-Program software

The software SMC-Program версии Ver.5 is intended for easy and convenient connection of the controller and motor control without learning of a data communications protocol of the controller.

The main application window is shown in the picture 9. The software is shut down and all connections are closed when the main application window is closed. To start an operation the controller should be connected through the SMC-Program. To connect the controller chose a menu item "Connect new device" in the main window.



Pic. 9. Main window of SMC-Program

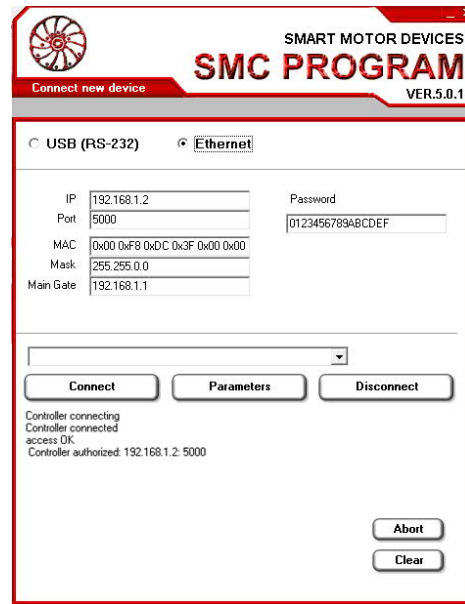

Pic. 10 – Controller connection window

Please, chose a connection type (USB or Ethernet) and check (change if necessary) the connection parameters in the appeared window (pic.10). The default parameters in the program correspond to default parameters of the controller. If the parameters were changed, new parameters should be set in the correspond fields.

In a password field the controller safety access code should be entered. The default code is 0x0123456789ABCDEF. This password can be changed in a window "Change password" (from a main window of the application).

For controller connection press the button "Connect".

If the connection was done successfully a relevant message will appear in the window. The controller will be available for operation in other windows of the application. A list of all connected controllers is available through a menu "List of connected devices" from the main application window (Pic.11).

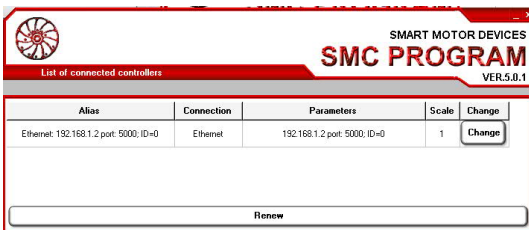

Pic.11. List of connected controllers

As a button "Change" is pressed (available for each of connected controllers in the list of connected controllers) a window of controller and motor parameters is appeared (Pic.12). The same window can be called from operation windows of the application "Program Load mode" and "Direct Control Mode" (Pic. 13 and Pic.14).

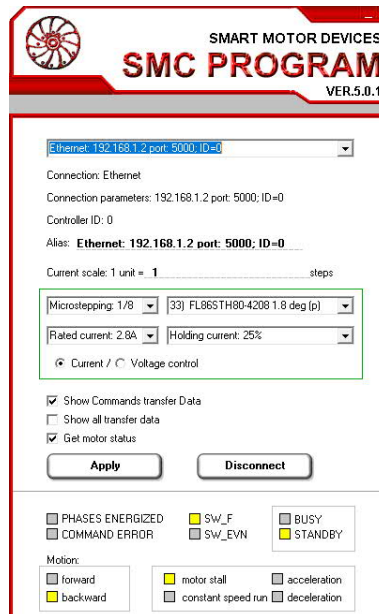

Pic.12. Controller parameters



SMART MOTOR DEVICES
SMC PROGRAM
VER.5.0.1

192.168.1.2 port: 5000; ID=0; ID: 0; Scale: 1

Ethernet: 192.168.1.2 port: 5000; ID=0

Controller parameters

List 1	N°	Command	Scaled	Param.	Code	Result
0		_SET_MIN_SPEED	100	100	_SET_MIN_SPEED	Ok

Speed Parameters:

- Set MIN speed: 100
- Set MAX speed: 15600
- Acceleration: 59000
- Deceleration: 59000
- Full step speed: 15600

Motion control:

- Permanent motion (speed 10000 steps/s) Forward Backward
- Move 4194303 steps Inc / abs
- Shortest way to 4194303 steps position
- Go Home (Zero position) Set Zero Position
- Move till signal to 1 input at Max / Min speed
- Pause: 4194303 ms Wait till signal to input 0

Additional commands:

- Go to command 1019 if input 0 Loop program
- Go to ext.program 1 Return program
- Switch to pulse control mode Turn relay ON

Stop:

Inputs: 0 1 2 3 4 5 6 7
State:
Mask:
Wait:

PHASES ENERGIZED SW_F BUSY STANDBY
COMMAND ERROR SW_EVN

Motion: Current speed: 100 forward motor stall acceleration backward constant speed run deceleration

Position: Total steps: 67389

Memory N° 0

Pic.13. Direct Control Mode window

SMART MOTOR DEVICES
SMC PROGRAM
VER.5.0.1

192.168.1.2 port: 5000; ID=0; ID: 0; Scale: 1

Ethernet: 192.168.1.2 port: 5000; ID=0

Controller programming - load program mode

Prog 1	N°	Command	Scaled	Param.	Code
0		_SET_MIN_SPEED	100	100	_SET_MIN_SPEED
1		_SET_MAX_SPEED	15600	15600	_SET_MAX_SPEED
2		_SET_ACC	59000	59000	_SET_ACC
3		_MOVE_F	4194303	4194303	_MOVE_F
4		_SET_WAIT	4194303	4194303	_SET_WAIT
5		_MOVE_R	4194303	4194303	_MOVE_R
6		_SET_RELE	0	0	_SET_RELE
7		_CALL_PROGRAM	1	1	_CALL_PROGRAM

Speed Parameters:

- Set MIN speed: 100
- Set MAX speed: 15600
- Acceleration: 59000
- Deceleration: 59000
- Full step speed: 15600

Motion control:

- Permanent motion (speed 10000 steps/s) Forward Backward
- Move 4194303 steps Inc / abs
- Shortest way to 4194303 steps position
- Go Home (Zero position) Set Zero Position
- Move till signal to 1 input at Max / Min speed
- Pause: 4194303 ms Wait till signal to input 0

Additional commands:

- Go to command 1019 if input 0 Loop program
- Go to ext.program 1 Return program
- Switch to pulse control mode Relay ON OFF

Stop:

Inputs: 0 1 2 3 4 5 6 7
State:
Mask:
Wait:

phases energized SW_F busy standby
command error SW_EVN

Motion: Current speed: 100 forward motor stall acceleration backward constant speed run deceleration

Position: Total steps: 67389

Memory N° 0

Pic.14. Program Load Mode window.

The windows Direct Control Mode and Program Load Mode are intended for a motor control, executing programs assembling, loading to the controller and reading from the controller. At the right side of these windows command buttons are located, at the left side the sent commands and their executing results are shown. Also information about state of I/O signals is available, state of signals can be changed just from a Direct control mode window. In the bottom side of the windows information of the controller state is shown.



10. Delivery in complete sets

Programmable stepper motor controller SMSD-4.2LAN or SMSD-8.0LAN	1 pcs.
USB cable for a computer connection	1 pcs.
LAN cable for Ethernet connection	1 pcs.
Manual SMSD. LAN	1 pcs.

11. Warranty

Any repair or modifications are performed by the manufacturer or an authorized company.

The manufacturer guarantees the failure-free operation of the controller for 12 months since date of sale when the operation conditions are satisfied.

The manufacturer sales department address:

Smart Motor Devices OÜ,
Tallinn Science Park Tehnopol, Akadeemia tee 21/6, 12618, Tallinn, Estonia
Phone: + 372 6559914,
e-mail: mail@smd.ee
url: <http://smd.ee>

Date of sale: