

19615

Coulisseau, profilé à gorge

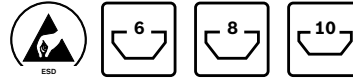

- ▶ Coulisseau pour une absorption sûre de forces importantes
- ▶ Profilé à gorge pour des éléments de fixation personnalisés à monter soi-même
- ▶ Usinage des profilés : inutile
- ▶ Ressort servant d'aide au montage et au positionnement pour le coulisseau et le coulisseau orientable (p. 3-8)



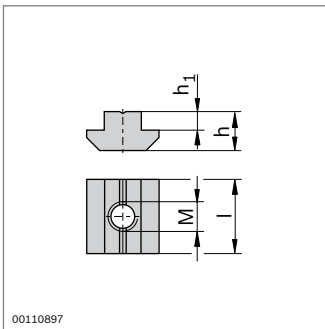









Caractéristiques techniques (p. 19-5)



00110897

Rainure	
6 (M5)	3 000 N
8 (M8)	6 000 N
10 (M8)	8 000 ... 24 000 N ¹⁾

¹⁾ En fonction du profilé (p. 19-5)

Coulisseau	Rainure	M	h (mm)	h ₁ (mm)	l (mm)	ESD		N°	
Acier ; galvanisé	6	M4	4,0	1,0	12		100	3 842 542 692	
		M5	4,0	1,0	12		100	3 842 542 693	
	8	M4	6,0	2,0	16		100	3 842 514 928	
		M5	6,0	2,0	16		100	3 842 514 929	
		M6	6,0	2,0	16		100	3 842 514 930	
	10	M8	6,0	2,0	16		100	3 842 514 931	
		M5	10,5	5,0	20		100	3 842 528 741	
		M6	10,5	5,0	20		100	3 842 528 738	
	Acier ; inoxydable	6	M4	4,0	1,0	12		100	3 842 523 140
			M5	4,0	1,0	12		100	3 842 523 142
		8	M4	6,0	2,0	16		100	3 842 547 817
			M5	6,0	2,0	16		100	3 842 547 816
M6			6,0	2,0	16		100	3 842 547 815	
10		M8	6,0	2,0	16		100	3 842 547 814	
		M5	10,5	5,0	20		100	3 842 547 813	
		M6	10,5	5,0	20		100	3 842 547 812	
		M8	10,5	5,0	20		100	3 842 547 811	

Accessoires : Ressort (p. 3-9)

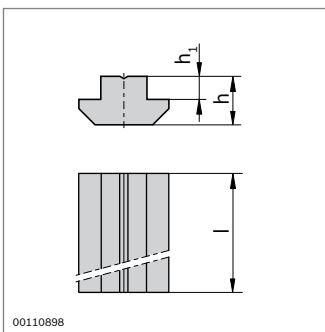

00110898

Profilé à gorge	Rainure	h (mm)	h ₁ (mm)	l (mm)	N°
Acier ; galvanisé	6	4,0	1,0	1000	3 842 542 694
	8	6,0	2,0	1000	3 842 510 078
	10	10,5	5,0	1000	3 842 528 744
Acier ; inoxydable	6	4,0	1,0	1000	3 842 523 438

Accessoires : Ressort (p. 3-9)